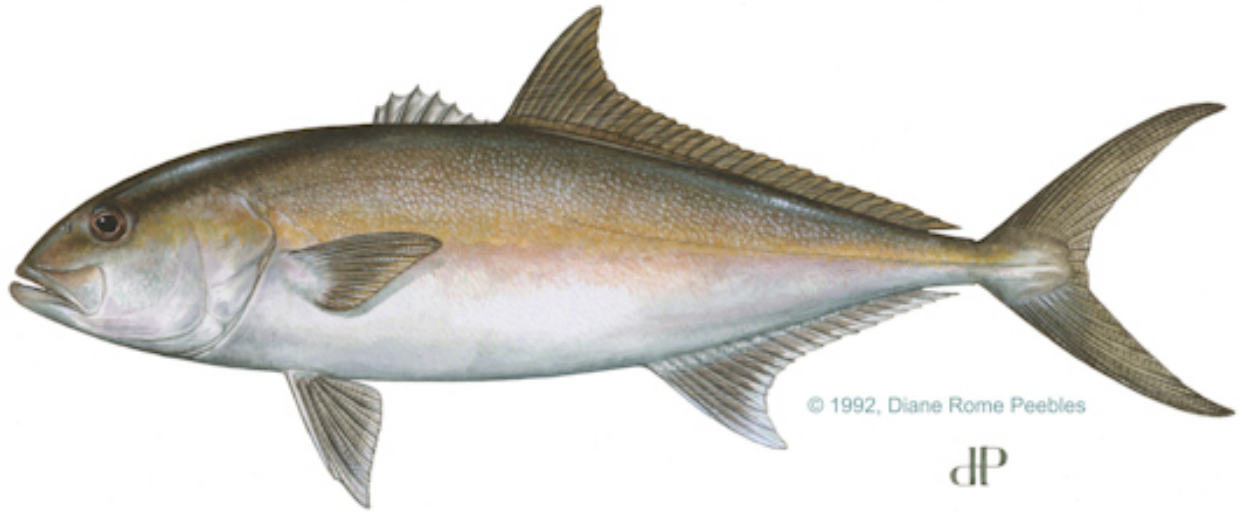


**SEDAR 33 Stock Assessment Update Report Gulf of Mexico Greater Amberjack**  
*(Seriola dumerili)*



© 1992, Diane Rome Peebles

DP

GREATER AMBERJACK (*Seriola dumerili*)

## Table of Contents

<b>1. Introduction</b>	4
<b>2. Data Review and Update</b>	4
<b>2.1. Commercial Fishery</b>	4
2.1.1. Landings in weight	4
2.1.2. Discards	5
2.1.3. Catch per unit of effort	6
2.1.4. Composition data	6
2.1.4.1. Retained catch length and age composition	6
2.1.4.2. Discard length composition	7
<b>2.2. Recreational Fishery</b>	7
2.2.1. Landings	7
2.2.2. Discards	9
2.2.3. Catch per unit of effort	9
2.2.4. Composition data	9
2.2.4.1. Retained catch length and age composition	9
2.2.4.2. Discard length composition	10
<b>2.3. Fishery independent survey data</b>	10
2.3.1. SEAMAP Reef fish Video survey and Panama City Video Survey Indices	10
<b>3. Continuity Model Update Approach</b>	14
<b>3.1. Life history metrics</b>	14
3.1.1. Stock definition	14
<b>3.2. Stock-recruitment model</b>	15
<b>3.3. Initial conditions</b>	16
<b>3.4. Abundance indices</b>	16
<b>3.5. Selectivity</b>	16
<b>3.6. Retention</b>	16
<b>4. Continuity Model Results</b>	17
<b>4.1. Spawning stock biomass, recruitment and exploitation rate</b>	17
<b>4.2. Abundance indices</b>	18
<b>4.3. Continuity Model Diagnostics</b>	19
4.3.1. Model convergence- Jitter analysis	19
4.3.2. Retrospective analysis	19

<b>4.5. Projections</b> .....	21
4.5.2 <i>Results</i> .....	21
<b>5. Conclusions</b> .....	21
<b>6. Research Recommendations</b> .....	<b>Error! Bookmark not defined.</b>
<b>7. References</b> .....	22
<b>9. Tables</b> .....	23
<b>10. Figures</b> .....	23
<b>11. Appendices</b> .....	23

## 1. Introduction

Since 2005 stock assessments of Gulf of Mexico (GOM) greater amberjack (*Seriola dumerili*) have been conducted under the Southeast Data, Assessment, Review process (SEDAR, <http://sedarweb.org/>). The most recent SEDAR assessment was the 2012 SEDAR 33 benchmark assessment (<http://sedarweb.org/associated-projects-species/greater-amberjack>). Prior SEDAR assessments include the SEDAR 9 benchmark and the SEDAR 9 update assessments (SEDAR 2011). Stock assessments of GOM greater amberjack conducted prior to the SEDAR process are found in Parrack (1993, 1996), McClellan and Cummings (1996) and Turner et al. (2000); the latter were reviewed by the Gulf of Mexico Fishery Management Council (GMFMC) Scientific and Statistical Committee (SSC) (<http://gulfcouncil.org/about/ftp.php>).

During the GMFMC, SSC review of the SEDAR 33 GOM Greater Amberjack assessment, the SSC selected a final model, for informing management advice that assumed stock-recruitment steepness parameter equal to 0.85 and the sigmaR parameter equal to 0.6. The resulting model estimated ratio for SSB<sub>current</sub> (2012) to SSB<sub>SPR30%</sub> was below 1.0 indicating the stock was overfished. The model estimated ratio of the estimated current fishing mortality ( $F_{\text{current}}$  = geometric mean of  $F_s$  over 2010-2012) to  $F_{\text{SPR30%}}$  was above 1.0 indicating the stock was undergoing overfishing.

This report summarizes the results of the ‘update assessment’ of SEDAR 33 GOM greater amberjack and is herein after referred to in this report as the “SEDAR 33 update”. The updated results from the SEDAR 33 continuity (base) assessment model are presented and compared to the SEDAR 33 benchmark assessment model.

## 2. Data Review and Update

The SEDAR 33 Data Workshop report provided details and a characterization of the fisheries for Greater amberjack in the Gulf of Mexico since the late mid 1950’s. The SEDAR 33 DW report may be found in Section II of the SEDAR 33 GAJ Stock Assessment Report (SAR, pages 39-201, <http://sedarweb.org/sedar-33-stock-assessment-report-gulf-mexico-greater-amberjack>). This section details the information on fishery statistics used in the SEDAR 33 update assessment.

### 2.1. Commercial Fishery

The history of reported commercial landings exists since 1963; although the general belief that some commercial removals prior to 1963 probably were occurring, the levels are not known. Two main gears are used to exploit GOM greater amberjack commercially, vertical lines and longlines. Removals by the longline fishery are considered indirect to the targeted species (e.g., snappers, groupers) of this fleet. Recorded statistics for vertical line and longline fleets include: landings (pounds whole weight), discards in numbers, observations of catch per unit of effort (CPUE, pounds/trip), and observations of size (length) and age.

#### 2.1.1. Landings in weight

Reported landings (whole weight) from 1963-2015 are presented in Error! Reference source not found. for the primary commercial fleets harvesting greater amberjack commercially: the vertical line and longline. The commercial landings time-series used for the update assessment was nearly identical to the commercial landings time series used for SEDAR 33 except for the additional years of data and some minor revisions to the longline series for three years (Error! Reference source not found., 3). As mentioned above, commercial landings of greater amberjack by the longline fleet represent a relatively small contribution to the total commercial landings over time averaging ~ 9 of all commercial landings over the time series (Error! Reference source not found.). Removals by the longline fleet of greater amberjack historically have comprised ~ 2 % of combined commercial and recreational landings. Reported commercial vertical line gear landings of this species increased gradually from 1963 through the mid-1980’s then increased significantly between 1986 and the early

1990's. Subsequently, landings declined significantly from the early 1990's to ~ 1998 (SEDAR 33 GAJ SAR, page 218 and Table 1 and Figure 1 this report). Commercial landings were variable from 1998 through ~ 2004 and declined from 2005-2008 with a subsequent increase in 2009. A minimum size was implemented in the GOM Exclusive Economic Zone (EEZ) in 1990 (36 inch Fork Length (FL), 91.44cm). A seasonal closure (1 March – 31 May) was implemented in 1998 in the GOM EEZ.

Since 2008 quotas have been established for GOM greater amberjack (GMFMC, Reef Fish Amendment 30A; GMFMC 2008). Overages occurred in 2009 and 2010 and the quota was revised downwards in 2011 and again in 2013. Overages have occurred in several years since the inception of Amendment 30A (2009-2013 and in 2015). The time series of commercial landings (metric tons, whole weight) input into the stock assessment model is presented in **Table 1** and **Figure 1**.

### 2.1.2. Discards

Information was available for the calculation of greater amberjack discards for the vertical line (hand line and electric/hydraulic reel gears) and bottom longline (reef fish and shark longline gears) from observer data in addition to fisher reported effort data from the National Marine Fisheries Service (NMFS), Southeast Fisheries Science Center (SEFSC), Coastal Fisheries Logbook Program (CLP). Data was complete for 2007-2015.

Calculation of commercial discards for the SEDAR 33 update assessment followed the procedures used in SEDAR 33 (McCarthy 2011). Because the discard calculations were finalized after the SEDAR 33 Data Workshop (DW) the methods were laid out in the final data update and assessment section of the SEDAR 33 SAR report (SAR, pages 75-79- "Preliminary analyses" and pages 219-220- "Final analyses") and are repeated here for convenience.

"Reef fish and shark observer program data included numbers and lengths of commercially discarded Greater Amberjack from fishing trips that were observed between July, 2006 and December, 2012. Discards of Greater Amberjack included all of the discards reported as Greater Amberjack as well as a portion of the discards reported as unclassified *Seriola*. The portion of unclassified *Seriola* discards included as discards of Greater Amberjack was estimated based on the proportion of Greater Amberjack less than 60 cm to all *Seriola* spp. less than 60 cm derived from trips where all fish were identified to species (most fish reported as unclassified *Seriola* were below 60 cm). As a result, in the longline fishery, 31.6 % of the unclassified *Seriola* less than 60 cm were assumed to be Greater Amberjack. For the hand line fishery, 27.1 % of the unclassified *Seriola* less than 60 cm were assumed to be Greater Amberjack.

For each year from 2007 to 2015, annual discard rates were calculated using observer reported data from the commercial reef fish and shark fisheries. Discard rates were calculated by Gulf of Mexico region (east and west) and fleet (hand line, reef fish longline permit, and bottom longline shark permit) according to the procedures in McCarthy (2011). A discard rate of zero was assumed for all regions and fleets prior to the implementation of the 36 inch fork length commercial size limit in 1990. From 1990 to 2006 (years assumed to have commercial discards, but prior to data collection by observers), discard rate was defined as the mean discard rate for the years 2007-2015 by fleet and region. Due to low numbers of observed longline trips per year, the annual discard rates from 2007 to 2015 for each longline fleet were replaced with the mean rate over the years 2007-2015 by fleet and region. Total discards for each year were calculated as: Year/fleet/region specific discard rate \*yearly fleet/region total effort reported to the coastal logbook program. Effort was in hook hours for the vertical line fishery and hooks fished for the longline."

The updated commercial discard estimates were similar to the estimates from SEDAR 33 (**Figure 4**) with only a few exceptions. Moderate deviations occurred in 2012 for the vertical line fishery

(Figure 4a, b). Discards for commercial vertical line fleet for SEDAR 33 update were lower than those of the SEDAR 33 benchmark, for the 2012 data year (-13.7 %). The addition of three new data years (2013-2015) into the discard catch rate estimation model and edits to the data base were the most likely reasons for this difference<sup>1</sup>.

Similarly, revisions to the longline discards observer data resulted in higher values for the SEDAR 33 update for 2008 and 2009 (39% and 16 % respectively, Figure 4b). The revisions mainly involved additional edits to remove duplicate observations and other data edits to the data base<sup>2</sup>.

### 2.1.3. Catch per unit of effort

Two commercial indices of abundance were recommended for use in the SEDAR 33 model. The indices are shown in Error! Reference source not found.. Overall the indices and the associated standard errors used during SEDAR 33 and the update were similar for the years through 2012 (Error! Reference source not found.a, b, c, d).

Data from the NMFS, SEFSC, and CFLP were used during SEDAR 33 to construct standardized CPUE indices of abundance for the GOM population of greater amberjack. The indices used the self-reported catch rate information for the vertical line and the longline fleets from the implementation of the CFLP logbook program in 1993 through 2009. The terminal year of data for the update assessment for the vertical line and longline was 2015. Procedures applied for CPUE standardization in the SEDAR 33 benchmark assessment were described in SEDAR 33-AW18. Appendix B provides details on the commercial CPUE standardization methods applied for the SEDAR 33 update assessment. Generally, a similar approach was used to develop the updated indices, however, for the updated analyses alternative models (i.e., a single series for all years (1990-2015) and also two split series (1990-2010, 2011-2015) were also explored in response to newly emerging patterns in the CPUE trends from the addition of new data (2013-2014). For use in the final stock assessment update model the single all year's series was used (1990-2015).

### 2.1.4. Composition data

#### 2.1.4.1. Retained length and age composition

The length data for the commercial fleets were obtained from the NMFS, SEFSC, and Trip Interview Program (TIP) and the Gulf Marine States Fisheries Commission (GSMFC) Gulf-FIN databases. All length observations were converted to fork length, partitioned by year and fleet, and grouped in 5cm bins following the convention of SEDAR 33 assessment for characterizing retained catch size composition of greater amberjack. There were no major changes in the length composition data of retained catch for commercial vertical line and commercial longline fleets (Error! Reference source not found.a, b).

The fleet specific annual length composition of retained catch used in the SEDAR 33 update model is summarized in Error! Reference source not found. for the a) vertical line and b) the longline fleets respectively. The visual depictions of the retained size composition show the progression of larger fish in the retained catch due to changes in the size limit in 1990 to a minimum size of 36 inches FL (91.4 cm).

Samples of age observations from the commercial fleets were available from the NMFS, SEFSC, Panama City Laboratory. Age samples were grouped into the same year-fishery specific strata as for the length samples. There were no major changes in the age composition data of retained catch for commercial vertical line and commercial longline fleets (Error! Reference source not found. a, b). The visual depictions indicate that the overall age composition was relatively unchanged from the SEDAR 33 benchmark assessment. Minor changes in the age composition occurred in the longline

|||||

"!#\$%&'()\*+,-./:;<=>?@

age composition; these were due to updates of the raw data files and removal of duplicates<sup>22</sup>. The annual age composition data are shown in Error! Reference source not found. for the a) vertical line and b) longline fleets. The visual depictions indicate that the vertical line fishery mainly exploits fish of age's three to six (**Figure 9a**). In general the longline fleet had very low sample sizes for age composition in all years.

#### 2.1.4.2 Discard length composition

Observations of discard lengths were available from the commercial vertical line and longline observer database however, most years were not sampled and the number of samples was extremely low in all years. As was done for the retained length composition, all lengths were converted to fork length, separated by fleet and year, and grouped in 5cm bins for use in the population model.

There were moderate changes observed in the greater amberjack discard length composition data for both the commercial vertical line fleet and longline fleets (Error! Reference source not found.a, b). The patterns was similar in the vertical line discard composition however the overall sample size was lower in the SEDAR 33 updated density (**Figure 10a**). The changes were due to revisions/edits to the raw data<sup>1</sup>. The discard length composition data for both the vertical line and longline fleet from 2007-2012 had a higher frequency of larger greater amberjack than SEDAR 33 (Error! Reference source not found.b).

The annual discard length composition data show that some fish above the size limit (36 inches FL-1990 (91.4 cm FL) were discarded by the vertical line and longline fleets (Error! Reference source not found.). The pattern in the size of discards was fairly consistent for both the vertical line fleet and longline fleets.

## 2.2. Recreational Fishery

Historically recreational fishing for greater amberjack has been dominated by the charterboat and private angler modes ('REC' fleet) followed by the headboat ('Headboat' fleet). Recorded statistics for these fleets includes: observations of landed catch, estimates of discards for the charter and headboat fleets, samples of length and weight, observations of catch and effort, and estimates of fishing angler effort. The sources for the recreational landings and discard estimates (1981-2015) were obtained from the Marine Recreational Fisheries Statistics Survey (MRFSS) and the Marine Recreational Information Program (MRIP), the Southeast Region Headboat Survey (SRHS), the Texas Parks and Wildlife Department (TPWD), and the Louisiana Creel Survey. Methods of estimation were summarized in SEDAR 33 (SAR DW Section, pages 63-74). Observations of length and age composition data were obtained from the MFRSS/MRIP, the Head Boat Survey, the Texas Parks and Wildlife Department database, the Gulf-FIN, and the TIP databases available from the NMFS, SEFSC, Fishery Statistics Division. Estimates of landed and discarded catch were available for 1981-2015. Catch estimates for the REC fleet were hind cast from 1950 to 1980 using the same procedures as for the SEDAR 33 benchmark assessment. Some consideration was given by the SEDAR 33 Catch Statistics Working Group to the history of exploitation for greater amberjack recreationally. It was generally thought by the group that recreational removals of Greater amberjack prior to 1950 were not large.

### 2.2.1.Landings

The time series of recreational landings used in the SEDAR 33 assessment model, those provided for the update assessment, and the percent difference are summarized in Error! Reference source not found. and 3. The recent period (1986-2012) headboat landings were unchanged (Error! Reference source not found.b). Differences in the hind cast headboat catch estimates were due to applying the SEDAR Best Practices Panel recommendations, for "hindcasting recreational catches" as these

|||||

®!#\$%&'(!) \* \* 'A'!5@\* . <!345!6786(2!#. <. \* .!(;/!C. D)% . /)%!9A)D\$%/'5@\* . <=<) . . '>):?!>

practices were not applied to hind cast headboat catch for the SEDAR 33 benchmark assessment as the 'Best Practices' workshop took place in June 2015 after SEDAR 33 completed.

Some changes in the updated recent period landings (1981+) were evident for the REC (charter and private angler combined) fleet (Error! Reference source not found.a, Error! Reference source not found.). The percentage differences in SEDAR 33 updated REC recent landings series were variable across years. The percentage difference from the SEDAR 33 and SEDAR 33 estimates ranged from -39% lower to 35% higher. Notable differences occurred in the early years of the time series: 1982-1985, 1984, 1987 and in 1998. Some background on the changes were available from the data providers (Appendix A. this document and included below for convenience).

“In 1998 there was a change in the post-stratified estimation methods. During 1987 sampling in West Florida (Monroe – Escambia county) was stratified to increase sample size in Monroe county in Wave 1, and in the western panhandle (Escambia to Bay county) in Waves 3-5. Catch and effort estimates were generated for these regions separate from the rest of West Florida, designated with  $st=90$ , then aggregated to report the 'state' totals for all of West Florida ( $st=12$ ). An error was discovered in the previous post-stratified program that failed to correctly convert effort estimates from  $st=90$  to  $st=12$  before being merged with the intercept data. This error was discovered in February 2015 and corrected. The resulting, corrected 1987 post-stratified estimates are included in this SEDAR 33 update for greater amberjack. The differences in the charter landings were more variable between 2004 and 2012.

As detailed in Appendix A, modifications have been made to the catch estimation procedures use the MRIP data and help to explain the differences. As referenced in Appendix A, adjustment factors for the recently implemented new 'Access Point Angler Intercept Survey (APAIS)' were applied and a new approach to removing the Monroe County landings was used (see Error! Reference source not found. for a description of the methods).”

Recent period headboat landings (1986-2012) remained unchanged as noted above (**Table 2b, Figure 12**). Also as noted in SEDAR 33 DW Report headboat landings for 1981-1985 were obtained from the MRFSS/MRIP survey for all states except Texas. A standard method used in past SEDARs (e.g., SEDAR 28-DW12) and applied here is to use the average Texas headboat mode estimates from SRHS from 1986-1988 to fill in the missing years. This differs slightly from SEDAR 9 when average Texas headboat estimates from 1986-1989 were used.

For SEDAR 33 benchmark assessment, historic estimates for the recreational charter and private angler catch and headboat were finalized after the SEDAR 33 Data Workshop and provided to the analyst for the benchmark assessment. Briefly, historical (1963-1980) recreational charterboat and private angler (Rec fleet) landings were estimated using the FHWAR method following the SEDAR Best Practices recommendations (SEDAR Best Practices, 2016). Fractional effort data were developed from FHWAR effort estimates for the GOM (excluding shore fishing). It was assumed that CPUE increased by 2% annually between 1963 and 1980 due to improvements in gear and other factors during the historic period. The 1980 landings were scaled to the mean landings between 1981 and 1985.

Previously for SEDAR 33, headboat landings were not hind cast using the procedure describe above, but instead a constant moderate level of catch from 1950-1980 was assumed. The change in approach for hindcasting headboat catch to the application of the FHWAR method is considered an improvement for hindcasting headboat catches prior to 1985 as it follows the recommendations from SEDAR Best Practices.



The SEDAR 33 update estimates of the historical recreational landings for the charter boat and private angler fisheries (REC fleet) were lower than those used in the SEDAR 33 assessment (Error! Reference source not found. **3a, Figure 12b**). The proportional difference was highest in 1950 and generally declined as the time-series approached 1981. The reason for the differences is in the updated estimate for the MRFSS/MRIP used to back cast from which, was lower by 28% for the REC (charter and private angler).

**Figure 13** and **Table 3b** presents the time series of headboat landings used in the SEDAR 33 update assessment and those from SEDAR 33 benchmark. Recent period landings were unchanged in the SEDAR 33 update. As previously noted the differences in the SEDAR 33 Update and SEDAR 33 headboat historic period estimates (**Table 3b**) is due to the applying the recommendations from the SEDAR Best Practices Workshop that convened after SEDAR 33.

### **2.2.2. Discards**

Estimates of discarded greater amberjack for recreational modes (REC, Headboat) followed the procedures used in SEDAR 33 and used the same data sources: the MRFSS/MRIP survey and the NMFS, SEFSC SHRS. As a reminder, the SEDAR 33 DW Discard working group chose to use the MRIP charterboat discard ratio as a proxy for all years, as charterboat ratios most closely matched the At-Sea Observer discards. **Table 4** provides estimates of discards for SEDAR 33 update and SEDAR 33 for the REC fleet (charter boat and private angler fisheries) and the headboat fleet. Generally, the update discard estimates for the REC fleet were consistently greater than the SEDAR 33 estimates (Table 4a). The greatest difference was 22% in 1982 and the smallest difference was 14% in 2002. The headboat discards have also been variable over time (**Table 4b**). The headboat discard estimates provided for the update were higher than the SEDAR 33 discards. The differences are due to application of the SEDAR Best Practices recommendations for estimating discards (SEDAR 2015).

### **2.2.3. Catch per unit of effort**

Observations of catch per unit of effort from the MRFSS/MRIP survey and the SHRS were the sources of information for these data. As in SEDAR 33 indices were developed for the recreational charter and private angler fisheries (REC fleet) and the headboat fishery (Headboat fleet). The resulting indices and standard errors are compared to the SEDAR 33 indices in Error! Reference source not found.. The updated indices and the associated standard errors were remarkably similar to those from SEDAR 33. Procedures applied for CPUE standardization in the SEDAR 33 benchmark assessment were described in SEDAR 33-AW 20 and AW 21. **Appendix C** provides details on the recreational CPUE standardization methods applied for the SEDAR 33 update assessment. Generally, a similar approach was used to develop the updated indices and as noted in **Appendix C**. Overall there was consistency in estimated trends between the SEDAR 33 update CPUE models and the SEDAR 33 benchmark recreational CPUE models. Estimated standard errors for the REC fleet were largely unchanged except for higher SEs for 1990, and 1994-1997. The estimated standard errors for the SEDAR 33 Update Headboat CPUE were larger for the SEDAR 33 Update.

### **2.2.4. Composition data**

#### *2.2.4 Retained catch length and age composition*

The length data for the commercial fleets were obtained from sources including: MFRSS/MRIP, the SEFSC, Headboat Survey, the Texas Parks and Wildlife Department (TPWD) database, the GSMFC Gulf FIN database, and the NMFS, SEFSC, TIP database. Procedures were identical to the approach used to process the commercial retained length and age composition for use in the assessment model. All length observations were converted to fork length, partitioned by year and fleet, and grouped in 5cm bins as applied to the data for the SEDSAR 33 benchmark assessment. Weighted length and age compositions for the combined charterboat and private angler fisheries (REC fleet) were developed by weighting the annual compositions (i.e., length or age) by the landings according to the procedure

described in SEDAR 7 and SEDAR 31. There were no major changes in the length composition data of retained catch for recreational charterboat and private angler (REC fleet) or the headboat fleet as shown in Figures **15a, b** for the REC and Headboat fleets respectively.

The fleet specific annual length composition of retained catch is summarized in Error! Reference source not found. for the SEDAR 33 update assessment. Shifts towards larger fish apparent in the retained catch since ~ 1990 were due to changes in the size limit that occurred in 1990 (30 inches FL, 71.12 cm, Amendment 1, GMFMC Reef Fish Fishery Management Plan (FMP). A subsequent change in the minimum size to 30 inches FL (76.2 cm) was implemented in August 2008 (Amendment 30A, GMFMC, FMP).

Age samples for the recreational fleets were from the NMFS, SEFSC, Panama City Laboratory. Age samples were partitioned into the same year-fishery specific strata as for the length composition samples. The main differences in the recreational retained age composition data of retained catch for was for the headboat fleet where some duplicate samples were identified during the early part of the SEDAR 33 update by the NMFS, SEFSC Panama City Laboratory age staff<sup>2</sup>. These duplicates were removed and the ageing observation datasets revised. Error! Reference source not found. (**a, b**) presents the updated SEDAR 33 and SEDAR 33 benchmark age composition densities. The annual age composition data are shown in **Figure 18**. The main age classes captured were 3-4 year olds (REC fleet) and 2-4 year olds for the Headboat fleet.

#### *2.2.4.2 Discard length composition*

The composition source for the discard length data was from two main sources: 1) the Florida Fish and Wildlife Conservation Commission's (FWC) Florida Fish and Wildlife Research Institute (FWRI) For-hire Survey Program ongoing since 2005 and 2) the NMFS, SEFSC Southeast Region Headboat Survey (SRHS). All lengths were converted to fork length, separated by fleet, and grouped in 5cm bins. Procedures used to process the discard length composition data for use in the assessment model followed that of SEDAR 33 and are briefly repeated here. Observations of discard length composition did not exist for the private angler fishery but were thought to be more similar to the headboat fleet thus the discard length composition was used to reflect private angler discard length composition. Weighted length compositions for the combined charterboat and private angler fisheries (REC fleet) were developed by weighting the annual compositions by the landings according to the procedure described in SEDAR 7 and SEDAR 31. **Figure 19** presents comparisons for SEDAR 33 update and SEDAR 33 benchmark assessment for the REC and Headboat fleets.

Annual length composition of recreational discards is provided in **Figure 20** for the SEDAR 33 update assessment. As evident in the commercial discard length composition, there was some small level of discarding of fish above the minimum size limit (28 inches FL (71.1 cm) established in 1990 and 30 inches (76.2cm) established in 2008). As noted earlier, length samples from the discarded catch were available beginning in 2005.

### **2.3. Fishery independent survey data**

#### *2.3.1. SEAMAP Reef fish Video survey and Panama City Video Survey Indices*

##### SEAMAP Survey Index

The SEDAR 33 SAR report (SEDAR 2012), provided background on the two fishery independent sources of data for use as measures of relative greater amberjack abundance and is included here for convenience.

“The primary objective of the annual Southeast Area Monitoring and Assessment Program (SEAMAP) reef fish video survey is to provide an index of the relative abundances of fish species associated with topographic features (e.g. reefs, banks, and ledges) located on the continental shelf of the Gulf of Mexico (GOM) from Brownsville, TX to the Dry Tortugas, FL. Secondary

objectives include quantification of habitat types sampled (video and side-scan), and collection of environmental data throughout the survey. Because the survey is conducted on topographic features the species assemblages targeted are typically classified as reef fish (e.g. red snapper, *Lutjanus campechanus*), but occasionally fish more commonly associated with pelagic environments are observed (e.g. hammerhead shark, *Sphyrna lewini*). The survey has been executed from 1992-1997, 2001-2002, and 2004-2012 and historically takes place from May – August. The 2001 survey was abbreviated due to ship scheduling, during which, the only sites that were completed were located in the western Gulf of Mexico. Types of data collected on the survey include diversity, abundance (minimum count), fish length, habitat type, habitat coverage, and bottom topography. The size of fish sampled with the video gear is species specific however greater amberjack sampled over the history of the survey had fork lengths ranging from 101.0 – 2065.0 mm, and mean annual fork lengths ranging from 571.8 – 759.9 mm. Age and reproductive data cannot be collected with the camera gear but beginning with the 2012 survey, a vertical line component will be coupled with the video drops to collect hard parts, fin clips, and gonads.

Various limitations either in design, implementation, or performance of gear causes limitations in calculating minimum counts and are therefore dropped from the design-based indices development and analysis as follows. In 1992, each fish was counted every time it came into view over the entire record time and the total of all these counts was the maximum count. Maximum count methodologies are not preferred and the 1992 video tapes were destroyed during Hurricane Katrina and cannot be re-viewed, so 1992 data is excluded from analyses (unknown number of stations). The 2001 survey was abbreviated due to ship scheduling, during which, the only sites that were completed were located in the western GOM. Because of the spatial imbalance associated with data gathered in 2001, that entire year has been dropped (80 total sites). Stratum 1 (South Florida) and stratum 7 (S. Texas) are blocks that contain very little reef and were not consistently chosen for sampling and were also dropped (184 total sites). Occasionally tapes are unable to be read (i.e. organisms cannot be identified to species) for the following reasons including: 1) camera views are more than 50% obstructed, 2) sub-optimal lighting conditions, 3) increased backlighting, 4) increased turbidity, 5) cameras out of focus, 6) cameras failed to film. In all of these cases the station is flagged as 'XX' in the data set and dropped (190 total sites). Sites that did not receive a stratum assignment are also dropped (62).

Delta-lognormal modeling methods were used to estimate relative abundance indices for red snapper (Lo *et al.* 1992). The main advantage of using this method is allowance for the probability of zero catch (Ortiz *et al.* 2000). The index computed by this method is a mathematical combination of yearly abundance estimates from two distinct generalized linear models: a binomial (logistic) model which describes proportion of positive abundance values (i.e. presence/absence) and a lognormal model which describes variability in only the nonzero abundance data (Lo *et al.* 1992).

Updated CPUE indices were developed for SEDAR 33 update using the same procedures as in SEDAR 33 and provided to the SEDAR 33 update assessment lead analyst.

#### Panama City Survey Index

The SEDAR 33 SAR report (SEDAR 2012) provides a background of the survey design, data filtering, and standardization methods for the Panama City index and is repeated here for context.

“In 2004 the SEFSC's Panama City laboratory initiated a fishery-independent trap survey (the survey) of natural reefs on the inner and mid-shelf of the eastern Gulf of Mexico off northwest Florida, and in 2005 video sampling was added. The survey's primary objective is to generate indices of relative abundance of federally-managed reef fishes for stock assessments and to

inform fishery managers. Target species include snappers (red, vermilion, gray, and lane), groupers (gag, red, & scamp), gray triggerfish, red porgy, white grunt, black seabass, hogfish, and amberjacks. Secondary objectives of the survey include examining community structure, annual regional catch, recruitment, distribution, and demographic patterns of economically and ecologically important reef fish species. Annual sampling is conducted May-September. In 2008 the Florida Fish and Wildlife Conservation Commission's Fish and Wildlife Research Institute (FWRI) joined with the Panama City and Pascagoula NOAA Fisheries Service labs in an effort to expand to the entire west Florida shelf the ongoing fishery independent reef fish surveys conducted by the latter two. Every effort is made to standardize the gear, survey design, sampling protocol, and analytical methods among the three agencies. All three groups collect visual data with stereo camera systems and Panama City and FWRI both use chevron traps. The estimator of abundance was the maximum number of a given species in the field of view at any time during the 20 min analyzed (= min count of Gledhill and Ingram 2004), and length measurements, made using Vision Measurement System software, were only taken from a still frame showing the min count of a given species to eliminate the possibility of measuring the same fish more than once. Details on survey design and methodologies are described in SEDAR33-AW05 (DeVries et al. 2013).

Censored data sets were used in deriving the indices of relative abundance from video data. Data – both habitat classification and fish counts – from all sites were screened, and those with no evidence that hard or live bottom was in close proximity, as well as sites where the view was obscured for some reason (poor visibility, bad camera angle), were censored (excluded) from indices calculations. As a result of this screening, of video samples from east of the Cape San Blas, only 31 of 41 in 2005, 47 of 89 in 2006, 23 of 57 in 2007, 56 of 66 in 2008, 62 of 97 in 2009, 95 of 109 in 2010, 99 of 115, in 2011, and 100 of 115 in 2012 met the reef and visibility criteria and were retained. Of samples from west of the Cape, 24 of 25 sites in 2006, 29 of 29 in 2007, 29 of 31 in 2008, 42 of 47 in 2009, 52 of 53 in 2010, 57 of 64 in 2011, and 49 of 59 in 2012 were retained for analyses.

Delta-lognormal modeling methods were used to estimate relative abundance indices for gag (Lo *et al.* 1992). The main advantage of using this method is allowance for the probability of zero catch (Ortiz *et al.* 2000). The index computed by this method is a mathematical combination of yearly abundance estimates from two distinct generalized linear models: a binomial (logistic) model which describes proportion of positive abundance values (i.e. presence/absence) and a lognormal model which describes variability in only the nonzero abundance data (Lo *et al.* 1992). The updated CPUE standardization followed the same methods and procedures outlined above<sup>4</sup>.

It should be pointed out that the Panama City Video Survey index was recommended by the SEDAR 33 benchmark Index working group conditionally. The WG provided this rationale (SAR page 149).

“The Panama City NMFS lab video survey index was conditionally recommended for inclusion in the stock assessment model for greater amberjack. This survey, with an 8 year time series beginning in 2005, covers the inner and mid-shelf of the northern portion of the west Florida shelf. The video survey strongly targets pre-recruit greater amberjacks - about 98% of those measured from stereo images during 2009-2012 were <762 mm FL, the recreational minimum size limit (Fig. 5.8.8). Although no age data were available from the survey, a comparison of the overall size distribution of greater amberjack measured from survey stereo images with age-specific size distributions derived from Florida specimens, ages 0-3, aged in other studies (subsample of age data described in Allman et al. 2013), strongly suggests that the majority observed were age 1, with fewer age 0's and 2's, and no age 3's (Fig. 5.8.9). Most, if not all, of the likely age 0 fish were only observed in 2012 – that year there was a modal group of small fish 154- 292 mm FL and

it was the only year there were any individuals <300 mm FL (Fig. 5.8.10). The survey has undergone some geographic and bathymetric expansion over time, and a switch from a systematic to stratified random design; however, the model was able to account for these differences with the addition of year, depth and region variables.”

Updated standardization results for the SEAMAP and Panama City Video surveys are shown in **Figures 21 and 22**. No major divergences in trends were noted between the update models and those from SEDAR 33 benchmark. The only exception is a slightly lower index value for the beginning of the time series (1993) for the SEAMAP survey (**Figure 21a**). All other year estimates were remarkably close. Of interest is an apparent declining trend in abundance for the SEAMAP survey after 2011. As well, the updated model predicted lower standard error of the indices than the SEDAR 33 benchmark (**Figure 21b**).

Overall, there were no inconsistencies in the Panama City Survey updated abundance estimates. The Panama City index overall is variable without major trends detectable (**Figure 22a**). The SEDAR 33 updated model predicted larger standard errors around the annual indices than the SEDAR 33 model (**Figure 22b**). The Panama City survey index represents a relatively short time series only beginning in 2006.

### *2.3.2 Fishery Independent Survey length composition*

Length composition samples of Gulf of Greater amberjack were updated for the SEAMAP Reef fish Video and the Panama City Laboratory Trap Video surveys. Field procedures were described in the SEDAR 33 SAR DW report (SEDAR 2012) and are repeated here for context.

“The SEAMAP reef fish survey has employed several camcorders in underwater housings since 1992. Sony VX2000 DCR digital camcorders mounted in Gates PD150M underwater housings were used from 2002 to 2005 and Sony PD170 camcorders during the years 2006 and 2007. 2008 a stereo video camera system was developed and assembled at the NMFS Mississippi Laboratories Stennis Space Center Facility and has been used in all subsequent surveys. The stereo video unit consists of a digital stereo still camera head, digital video camera, CPU, and hard drive mounted in an aluminum housing. All of the camcorder housings we have used were rated to a maximum depth of 150 meters while the stereo camera housings are rated to 600 meters. Stereo cameras are mounted orthogonally at a height of 50 cm above the bottom of the pod and the array is baited with squid during deployment.

At each sampling site the stereo video unit is deployed for 40 minutes total, however the cameras and CPU delay filming for 5 minutes to allow for descent to the bottom, and settling of suspended sediment following impact. Once turned on, the cameras film for approximately 30 minutes before shutting off and retrieval of the array. During camera deployment the vessel drifts away from the site and a CTD cast executed, collecting water depth, temperature, conductivity, and transmissivity from the surface to the maximum depth. Seabird units are the standard onboard NOAA vessels however the model employed was vessel/cruise dependent”

Length composition samples were handled identically to the recreational and commercial length composition samples. For the update assessment, as with the processing of all other composition data (i.e., retained and discarded composition individual survey length observations were aggregated by year and 5-cm length bins for use in the stock assessment update model. A comparison of the survey length composition for the SEDAR 33 update and the SEDAR 33 benchmark assessment is shown **Figures 23 and 24**. The updated SEAMAP length composition was very similar to that of the SEDAR 33 benchmark. During the initial phase of processing the Panama City Video length composition for the update assessment, it was determined that observations from 2009 had been coded as ‘SEAMAP’ survey inadvertently in the SEDAR 33 benchmark. **Figure 24** presents the updated Panama City length

composition, that of the SEDAR33 benchmark, and the corrected length composition for SEDAR 33 with the 2009 data included. The effect of this error on the population model results was inconsequential as the contribution of the Panama City Survey length composition to the total overall length composition likelihood was 0.6% (Individual length likelihoods from SEDAR 33: Com\_HL-22.7%, Com\_LL-10.5%, REC-27.7%, Headboat-28.8% and SEAMAP Video-9.7%).

### 3. Continuity Model Update Approach

As in the previous SEDAR 33 benchmark assessment a length-based, age-structured forward-projecting population model was used to assess the status of the GOM greater amberjack stock. The population model was implemented in the software package “Stock Synthesis 3” (SS3, Methot 2010). Model configuration specifications were maintained consistent to the final SEDAR 33 benchmark model configuration and is briefly described below.

The start year of the SEDAR 33 update model assessment period begins in 1950 and the final (terminal) year of the assessment was 2015. Data collection was assumed to be relatively continuous throughout the year; therefore inclusion of a seasonal component to the removals was not deemed necessary. The fleet structure in the model included two commercial fleets, the vertical line (Com\_HL) and longline (Com\_LL), two recreational fleets, the combined charter and private recreational modes (REC), and a headboat (Headboat) fleet. The fleet structure was identical to the fleet structure modeled in the SEDAR 33 benchmark assessment. The data available for the SEDAR 33 update assessment are shown in Figure 26.

The continuity (‘update’) model configuration was identical to SEDAR 33. The continuity model for this assessment included greater amberjack length bins from 10 cm Fork Length (FL) to 150 cm FL and age classes from age zero through age10. The age 10 “plus group” included fish ages 10 and older.

The r4ss software (<https://github.com/r4ss/r4ss>) was utilized extensively to develop various graphics for the SS outputs and also was used to summarize various SS output files including various profiling scenarios and model comparisons.

#### 3.1. Life history metrics

##### 3.1.1 Stock definition

Two management groups (Atlantic and Gulf of Mexico) are currently used by the SAFMC and GMFMC for greater amberjack management. The geographic boundary of these management units occurs from approximately the Dry Tortugas through the Florida Keys and to the mainland of Florida. Discussion by the Life History Working (LHWG) group during SEDAR 33 indicated that while there was evidence for sub-regional structure in the Gulf, “there was not enough compelling evidence to change stock structure”. Therefore, the SEDAR 33 LHWG recommended keeping the two stocks (Atlantic and Gulf) as two separate management units without further subdivision within the Gulf stock. This stock definition was maintained in the SEDAR 33 update assessment

##### 3.1.2 Weight-length, maturity, fecundity, growth, and discard mortality

Model specifications for the weight-length, maturity schedule, fecundity, natural mortality, growth, were consistent with SEDAR 33. Parameter values for the weight-length relationship, maturity schedule, and fecundity were fixed at the values given in the DW Workshop report (SEDAR 2012, **Appendix D.**) this report). The Greater Amberjack maturity ogive was input as a fixed logistic function of age with full maturity set for ages 2 plus as recommended by the SEDAR 33 DW (SEDAR 2012). For the SS Base model configuration natural mortality was modeled as a declining ‘Lorenzen’ function of size constant over time, scaled to the Hoenig maximum age estimator point estimate as described in the SEDAR 33 SAR (Data Update and Review Section 217-218 and SEDAR

2012 SAR Figure 2.1.1, page 248). The same rate of discard mortality assumed for SEDAR 33 benchmark was assumed in the SEDAR 33 update assessment (0.2 for recreational charter and private angler (REC) and for the Headboat fleets and 0.1 for the commercial vertical line and longline fisheries).

Growth was modeled using the same approach as in SEDAR 33. Growth was modeled internally in SS as both sexes combined using a three parameter von Bertalanffy equation ( $L_{\min}$ ,  $L_{\max}$ , and  $K$ ) (SEDAR 33 SAR, Figure 2.2.1.1, SEDAR 33 2012). For the SEDAR 33 update assessment, the Linfinity parameter was fixed at the value estimated by the SEDAR 33DW (143.6 cm FL) and the growth rate  $K$  parameter was estimated by SS update model.

In SS, when fish recruit at the real age of 0.0 the body size is set equal to the lower edge of the first population bin ( $L_{\text{bin}}$ ; fixed at 10-cm FL for the Greater amberjack stock assessment). Then, individuals grow linearly until they reach a real age ( $A_{\min}$ ). Then after reaching  $A_{\min}$  (at  $L_{\min}$ ), as fish advance in age, the size at age is characterized according to a von Bertalanffy growth equation. The value of  $A_{\min}$  was fixed at 0.5 (as in the SEDAR 33 benchmark model), a fractional age which is representative of the midpoint of the spawning period (April per the SEDAR 33 DW, SEDAR 33 2012). The  $L_{\min}$  value was selected for  $A_{\min}$  based on empirical size at age observations by month provided by the DW, from the age 0 fish provided in the age-length data.  $L_{\max}$  was specified as equivalent to  $L_1$ . Variation in size at age was fixed ( $CV = 0.2$ ) for the greater amberjack SS model since information on size conditioned on age was not available.

### 3.2. Stock-recruitment model

As in the SEDAR 33 benchmark assessment the SS model configuration assumed a single Beverton-Holt stock-recruitment function and two “S/R” parameters were estimated in the model; the log of unfished equilibrium recruitment ( $R_0$ ) and an offset parameter defining the initial equilibrium recruitment relative to virgin recruitment ( $\log(R_1)$ ). For the SEDAR 33 update, the steepness ( $h$ ) parameter was set equal to 0.85. In the SEDAR 33 benchmark assessment, the steepness parameter was estimated throughout most of the SS runs (result = 0.898) including those presented to the SEDAR 33 CIE Panel, however, at the GMFMC, SSC review (May 2014) the SSC selected a fixed value of 0.85 for use in setting management advice. During the May 2014 SSC review the lead analyst presented a summary from a literature review on steepness as relates greater amberjack and/or reef fish species in general. This review suggested that in most simulation analyses steepness parameter was bound high and in other cases, was over-estimated. The SSC felt that steepness = 0.85 was appropriate for greater amberjack. The third S/R parameter representing the standard deviation in recruitment ( $\text{sigmaR}$ ) was input as a fixed value of 0.6. This final assumption of maintain  $\text{sigmaR}=0.6$  was carried over from SEDAR 33 benchmark assessment.

Stock Synthesis is hard-coded to model recruits as age 0 fish. Annual deviations from the stock-recruit function were estimated in SS as a vector of deviations forced to sum to zero. Stock synthesis assumes a lognormal error structure for recruitment. Therefore, expected recruitments were bias adjusted. Prior to 1984, no length or age composition data are available for greater amberjack, therefore no recruitment deviations were estimated. Instead the recruitment is fixed at the expected value obtained from the spawner-recruit relationship. Therefore, during this period the estimates are very precise ( $\sigma^2=0$ ). Full bias adjustment was used from 1985 to 2014 when length and age composition data are available. Bias adjustment was phased in from no bias adjustment prior to 1979 to full bias adjustment in 1985 linearly. Bias adjustment was phased out over the last two years (2014-2015), decreasing from full bias adjustment to no bias adjustment, because the age composition data contains little information on recruitments for those years. The years selected for full bias adjustment were estimated following the methods of Methot and Taylor (2011). Methot and Taylor (2011) recommend that the full bias adjustment only be applied to data-rich years in the assessment

and a few years into the data-rich period. This is done so SS3 will apply the full bias-correction only to those recruitment deviations that have enough data to inform the model about the full range of recruitment variability (Methot 2011).

### **3.3. Initial conditions**

The population model began in 1950 and the terminal year of data was 2015. As mentioned in the fishery data section describing recreational removals some landings occurred prior to 1950 thus the population was not assumed to be in equilibrium and so the initial offset to equilibrium parameter (R1) was estimated in the model for the two recreational fleets (REC, Headboat).

### **3.4. Abundance indices**

Six time series of abundance indices were available for use in assessing greater amberjack. Four indices represented fishery dependent observations (Com\_HL, Com\_LL, REC, and Headboat) and two fishery independent times' series were available (SEAMAP Reef Fish Video and Panama City Video). In the model framework the Com\_HL, Com\_LL, and Headboat were configured as landed fish only. As the REC time series includes data on both landed and discarded fish the REC time series was configured as a survey. The population model is able to incorporate the amount of error on the index estimate. In the model, each index was assumed to have a log normal error structure with the error defined as  $\log_e(\text{index})$ . For each of the indices the CV (i.e., standard error of the observation divided by the mean value of the observation) was provided by the analyst consistent with standard SS conventions. Then, the error was approximated as  $\sqrt{\log_e(1+CV^2)}$ .

### **3.5. Selectivity**

Size based selectivity patterns were specified for each fishery and survey in SS. Double normal functions were used to model selectivity for all of the fleets and surveys (i.e., Com\_HL, REC, Headboat, Panama City Video), except the commercial longline and the SEAMAP video survey, because of the flexibility this functional form provides. The double normal can be used to model dome-shaped selectivity, but it can also approximate asymptotic selectivity by fixing several of the function's parameters. A logistic function (asymptotic) was used to model selectivity for the commercial longline (Com\_LL) and the SEAMAP video survey. Thus, six selectivity patterns were defined in the SS update assessment model corresponding to each fishery or survey: 1) commercial vertical line gear (COM\_HL), 2) commercial longline gear (COM\_LL), 3) recreational charterboat and private angler combined (REC), 4) headboat fishery (Headboat), the 5) SEAMAP video survey (SEAMAP Video), and 6) Panama City Laboratory trap video Survey (Panama City Trap Video Survey). The SEDAR 33 Assessment Panel (AP) felt that using an asymptotic function to model the commercial longline fleet selectivity patterns was more representative, because there was no strong evidence of dome-shaped selectivity and the fit of the model was slightly improved (as reflected in smaller residuals) than when specifying a dome selectivity function.

Selectivity patterns were assumed to be constant over time for each fishery and survey.

### **3.6. Retention**

Time-varying retention functions were used to allow for varying discards at size due to the impacts of fishery minimum size and bag limit regulations. The retention function in SS3 is specified as a four parameter logistic function. An inflection parameter describes the size at which 50% of a size class is retained, the standard deviation parameter, the asymptote parameter which describes the maximum proportion retained above a particular size class, and a male offset parameter that was not used. Retention functions were allowed to change with changes in the minimum size using "time-blocked" retention functions.



Size limits were first implemented in 1990 (36 inch fork length- COM\_HL and COM\_LL fleets and 28 inch fork length- REC and Headboat fleets) and in 2008 (30 inch fork length- REC and Headboat). Additional time blocks were defined for both the recreational and commercial vertical line fisheries aligning with fishery closures and/or management quotas (2008- COM\_HL, and 2009- REC, Headboat). To summarize, the commercial fishery time varying retention blocks were defined as: 1) COM\_HL 1950-1989, 1990-2007, 2008-2015 and 2) COM\_LL as: 1950-1989, 1990-2015. Time varying retention blocks were defined for the REC and Headboat fleets as: 1950-1990, 1991- 1998, 1998-2008 and 2009-2015.

#### 4. Continuity Model Results

**Appendix D** provides detailed comparisons of all model fits for the SEDAR 33 update model and the SEDAR 33 benchmark model. Results included are predicted parameter values and their associated standard errors from SS, initial parameter values, minimum and maximum values a parameter could be assigned, and the prior densities assigned to each parameter (if a prior was used).

##### 4.1. Spawning stock biomass, recruitment and exploitation rate

Trends in key derived quantities are presented in **Figure 27** for the SEDAR 33 update model and the SEDAR 33 benchmark model. The trends in SSB, Recruits, recruit deviations and exploitation rates (i.e., catch in weight including discards divided by total biomass) are similar between the updated model and the SEDAR 33 benchmark (**Figure 27**).

Trends in SSB were more different in the early part of the time series (**Figure 27a**) aligning with the time point in the assessment input data time series characterized as having less informative data. The data rich component of the time series begins in ~ 1984. The estimated unfished spawning biomass of the SEDAR 33 update model was somewhat larger than for the SEDAR 33 benchmark model (**Figure 27a**). As previously noted in the Data section, the estimates of historic recreational landings and discards were changed in the update data. Revisions in historic landings and discards were due to revisions in the MRFS/MRIP calibration estimates (REC fleet) and use of SEDAR Best Practices recommendations (SEDAR 2015) for estimating historic headboat historic landings.

The offset recruitment parameter estimate was slightly lower for the SEDAR 33 update model producing a larger estimate of SSB in 1950 (**Figure 27a**). SSB trends from the SEDAR 33 update model and the SEDAR 33 benchmark model were very similar from ~ 1988 through ~ 2009. After 2009, lower SSB levels were estimated for the SEDAR 33 update model and higher exploitation rates (**Figure 27a, b**).

The overall trends in exploitation rate of greater amberjack were similar between the SEDAR 33 update and SEDAR 33 benchmark models. During the early time series exploitation rates were higher for the SEDAR 33 benchmark assessment. From the mid 1990's through the present time exploitation rates were higher for the update model (**Figure 27b**).

Estimates of Age-0 recruits and recruitment deviations are presented in **Figure 27c, d**. The pattern and level in age 0 Recruits was relatively consistent until ~ 2007. Around 2007, the level of age 0 recruits was lower for the update assessment. While the trend in recruitment deviations was similar, after ~ 2009 the magnitude of the deviations were much higher for the SEDAR 33 benchmark model. Age-0 recruits (2009 cohort) would have entered the recreational fisheries about 2011 or 2012. The SEDAR 33 update model generally predicted lower levels of recruits after 2009 except in one year, 2011.

The estimated length and age estimated selectivity functions for each fleet and survey for the SEDAR 33 update and SEDAR 33 benchmark assessments are shown in **Figures 28 and 29**. No discernable

differences in selectivity estimates are visible between the SEDAR 33 update and benchmark assessments for Com\_HL, the Com\_LL, or the REC fleets. There were some changes in estimated selectivity for the Headboat fleet from the SEDAR 33 benchmark. Both the length and age Headboat selectivity curves from the update model suggests slightly lower selectivity for smaller and younger fish (**Figure 28, 29**).

#### **4.2. Abundance indices**

The fits of the relative indices of abundance for the SEDAR 33 update and SEDAR 33 benchmarks are shown in **Figures 30-35**.

##### *4.2.1 Commercial Vertical line fleet*

The fits to the commercial indices are similar until ~ 2010 where both series show large divergence. For both the commercial vertical line (Com\_HL) and the longline (Com\_LL) fleets, a significant change in the trend in both nominal and standardized CPUE was evident beginning in 2010 (**Appendices B, C**). For the Com\_HL a significant increase (~ four fold) in CPUE was observed after 2010 while a significant decline in CPUE was observed for the Com\_LL fleet. These patterns suggested some type of methodological changes in fishing operations, such as a switch in targeting, could have impacted the CPUE trends. The changes could have been the result of decreased season lengths and quota limitations since 2010 and/or the implementation of an Individual Fishing Quota (IFQ) for the shallow-water groupers in 2011.

The SEDAR 33 benchmark model included the Com\_HL and Com\_LL indices as a single time series in SS model. This convention was also used in the SEDAR 33 update model however, a link parameter was added to the model to allow for possible change in catchability in 2010. This added one extra parameter to the SEDAR 33 update model that was not previously included since no change in catchability (Q) was indicated. The SEDAR 33 benchmark assessment also used the Com\_HL and Com\_LL time series however the series was truncated in year 2010. With the addition of link parameter to the SEDAR 33 update model, the full time series was used allowing incorporation of all the data through 2015 into the SS3 model. The implications of this approach were examined in a sensitivity analysis to the update model and are discussed below in **Section 4.2.2** (Sensitivity Analysis on Com\_HL abundance indices).

The resulting fits to the Com\_HL indices were similar between the update and benchmark model up until ~ 2002. After 2002, the update model tends to fit the index data better up through the year of common data (2010) (**Figure 30**).

The resulting fits to the Com\_LL indices are not as similar between models (Figure 31). The SEDAR 33 update model tends to fit the CPUE better than the SEDAR 33 benchmark model up through ~ 2002. Neither model fit the Com\_LL indices very well after 2002.

##### *4.2.2 Sensitivity Analysis on the SS model for the Com\_HL Index*

There was some concern about the divergent patterns in the Com\_HL CPUE index after 2010. The SEDAR 33 benchmark assessment modeled the Com\_HL index as a single time series truncating the data in 2010. Explanations for the drastic change in vertical line CPUE were not readily available for the update assessment thus a sensitivity analysis was conducted on the SEDAR 33 update model to explore the use of a truncated Com\_HL index. The SS update model results indicated that the both the survey and discard model fits were slightly degraded for the Sensitivity model (likelihoods: survey (-49.0 (sensitivity), -51.8 (SEDAR 33 preferred update model) and discard (307.4 (sensitivity), 306.2 (SEDAR 33 preferred update model)). As well, the sensitivity model required nearly one hour to reach convergence while the preferred base update model only ~ 4 minutes to reach convergence. Thus, it was felt that preserving the better fit for the discard and survey data components supported

using the full Com\_HL index data (1990-2015) for the update assessment and to encourage additional exploration of the change in CPUE for the next benchmark assessment of GOM greater amberjack.

#### 4.2.3 *Recreational REC and Headboat Indices*

In general the fits to the recreational charterboat and private angler (REC) indices were very similar. Both models ignored the large spikes in CPUE observed in the early time period of the REC survey (1985-1990) which were also characterized by large CV's (a measure of uncertainty). After 1990, the trends are mainly flat, excepting a moderate increase in CPUE between 1999 and 2002. The fits are nearly identical between models (**Figure 32**).

The model fits to the Headboat fishery relative abundance indices are shown in **Figure 33**. SS3 fit the entire time series, 1986-2012, similarly for the SEDAR 33 update and the benchmark model. Slight improvements in the fit for some individual years are evident for the SEDAR 33 update model however there are no large discernable differences in model fits overall.

#### 4.2.4 *SEAMAP Reef Fish and Panama City Video Survey Indices*

**Figures 34 and 35** presents the SEDAR 33 update assessment model fits to the SEAMAP and Panama City Video Survey Indices. The fits are mostly similar between models however the SEAMAP survey index had a slight improved for the SEDAR 33 update model during a few years 2007-2010. The Panama City index was not fit well by either model.

### 4.3. Continuity Model Diagnostics

**Appendix E** provides detail visual presentations of all model fit comparisons for the SEDAR 33 update model.

#### 4.3.1 *Model convergence- Jitter analysis*

Uncertainty in model parameter estimation performance was addressed for the SEDAR 33 update model through an internal SS parameter "jitter" option which randomly changes the input parameter by a specified value. A jitter value of 10% was input for the assessment and 200 runs made for the SEDAR 33 update model configuration. SS carries out the jitter exercise by randomly changing the initial starting values of the parameters by a fixed amount (i.e., 10% jitter fraction was specified for the update assessment) thus altering the starting estimates across many runs. The purpose in changing the parameter starting estimates across numerous models is to explore the model's ability to reach a global solution (i.e., minima) from starting at different places along the likelihood space.

The results of the jitter analysis are shown in **Table 5 and Figure 36**. The total likelihood value for the SEDAR 33 update model was 1191.02 and the likelihood value for the model with the lowest jitter was 1186.58. Overall the jitter analysis indicates the update model was reasonably stable and the update model and the model with the lowest likelihood having nearly identical results for each primary data component and in the estimates of key quantities such as spawning biomass, exploitation rate, age-0 recruits, recruit deviations (**Table 5, Figure 36**). The update model was considered the preferred model as the survey fit was improved for the update model as measured by a lower likelihood value (survey data likelihood = -51.83 for the update model and was -51.08 for the jitter run with the lowest total likelihood value). The jitter result in addition to concern by the SEDAR 33 Assessment and Review Panels on the quality and fit of the length frequency composition adds further support for the update model as the preferred model.

#### 4.3.2 *Retrospective analysis*

Model performance was examined using retrospective analysis. For these the SEDAR 33 update model was refit while sequentially dropping the last four years of data one year at a time (i.e., 2015, 2014-2015, 2013-2015, and 2012-2015) with all other SS inputs remaining unchanged. Retrospective analysis is used to look for systematic bias in estimates of key model output quantities such as spawning biomass, fishing mortality, spawner-recruit parameters, etc. over time. **Figure 37** provides the graphical output for these key quantities: spawning biomass (SSB), age-0 recruits, recruitment deviations, and the density of the estimate of unfished biomass, for each of the retrospective runs, and the SEDAR 33 update model. These results indicate that the estimation of these key quantities (spawning biomass (SSB), age-0 recruits, recruitment deviations, and the density of the estimate of unfished biomass) in the SEDAR 33 update model was generally not affected by the removal of one or more years of data.

Following recommendations of the GARM Working Group (GARM 2008), the presence of a retrospective pattern was considered for the spawning stock biomass metric (SSB). The objective of examining retrospective patterns is to identify incongruence in model estimation between one or more models. In fisheries stock assessment retrospective patterns can be due to a variety of factors some from uncertainty and others from biases in assumptions. Mohn’s rho and the NMFS, Woods Hole Laboratory modified Mohn’s rho (“Woods Hole rho”) were both computed. Mohn’s rho is computed as:

$$!!! ! \quad ! \quad \frac{(!!" !"#$,!"#\$ model ! !!" #\$&, full model)}{!"#\$!, full model}$$

The Woods Hole rho modifies the Mohn’s rho formula to compute the sum of the differences over all years in each retrospective year and not just the terminal year. The results suggest there is no strong retrospective pattern in the greater amberjack assessment results either using Mohn’s or the Woods Hole rho statistic (Mohn’s rho = -0.22, Woods Hole rho = 0.10). Mohn’s rho suggest a minor negative retrospective pattern while the Woods Hole rho suggested a slight positive retrospective pattern.

#### 4.4. Stock status

For the Gulf of Mexico Greater amberjack benchmarks and reference point calculations, SPR30% was selected as an MSYT-proxy, and used to calculate stock status. The minimum stock size threshold (MSST) is defined as  $(1-M) * SSB_{MSY}$  (F30% SPR) where the M values used was the point estimate of M for fully recruited ages, resulting from the Hoenig maximum age natural mortality estimator recommended by the SEDAR 33 Data Workshop (i.e.,  $M = 0.28y^{-1}$ ). The maximum fishing mortality threshold (MFMT) is defined as F30%SPR. A stock is declared overfished if  $SSB_{current} < MSST$  and overfishing is occurring if  $F_{current} > MFMT$ . For purposes of calculating  $F_{current}$ , “current time period” is defined as the geometric mean of  $F_s$  for 2013-2015.  $SSB_{current}$  is the model estimated SSB for calendar year 2015. In addition, FOY is defined for the Greater amberjack stock as 75%F30%SPR. Recruitment deviations were not calculated for the forecast years; instead, recruitment was derived from the model estimated stock-recruitment relationship

The annual estimates of SSB and exploitation relative to the management reference points (e.g.,  $SSB_{FSPR30\%}$ , MSST, FSPR30%) for the SEDAR 33 update model and the SEDAR 33 benchmark model are shown in **Figure 38**. The results indicate that Gulf of Mexico greater amberjack is currently overfished (**Figure 38a, b**) and undergoing overfishing (**Figure 38c**).

Tabulated results of SSB and exploitation relative to the management reference points (e.g.,  $SSB_{FSPR30\%}$ , MSST, FSPR30%) are shown in **Table 6**. These results indicate the Gulf of Mexico

greater amberjack stock is currently overfished ( $SSB_{2015}/MSST = 0.40$ ) and undergoing overfishing ( $F_{current}/MFMT=1.68$ ). The results also indicate greater amberjack stock has been overfished in all years since ~ 1987 and the stock has been undergoing overfishing since 1985. The results of the update assessment were generally consistent with the SEDAR 33 benchmark assessment. However, the SEDAR 33 update was somewhat more pessimistic with regard to stock status. The update assessment produced lower estimates of  $SSB/SPR_{30}$  and higher estimates of  $F/SPR_{30}$  in the most recent years.

#### 4.5. Projections

##### 4.5.1. Procedures

Deterministic projections were carried out to evaluate stock status for a period of 10 years beginning in 2016 using the “forecast” option in SS. The terminal year of data for the stock assessment was 2015 therefore in order to initialize the projection at 2017, the 2016 landings were obtained from SEFSC, FSD. Stock Synthesis (SS) estimates the fishing mortality rate to achieve the input 2015 catch value and estimates age 0 recruits from the estimated spawner-recruit model and the 2015 estimate of  $SSB$ . The evaluations were made according to these MSRA criteria:

A) If stock is overfished:

$F=0$ ,  $F_{current}$ ,  $FMSY$ ,  $FOY$

$F=F_{Rebuild}$  (max that permits rebuild in allowed time)

B) If stock is undergoing overfishing:

$F= F_{current}$ ,  $FMSY$ ,  $FOY$

C) If stock is neither overfished nor undergoing overfishing:

$F= F_{current}$ ,  $FMSY$ ,  $FOY$

##### 4.5.2 Results

SS provides estimates of forecast catches for total and retained yields. For the SEDAR 33 GOM update OFL was calculated the same way as for the SEDAR 33 benchmark. OFL was the SS model point estimate of retained yield (MTons) using the projection of  $FSPR_{30\%}$ . The allowable biological catch (ABC) was calculated as the retained yield using the projection of  $75\%FSPR_{30\%}$ . An alternative projection was calculated as the retained yield using the projection of  $FSPR_{40\%}$ .

SS estimated model forecast OFL, ABC, and  $F_{Rebuild}$  catch levels are shown in **Table 7** and **Figure 39** according to the MSRA criteria specified or the SEDAR 33 update model. Also provided are the OFL, ABC,  $F_{Rebuild}$  catch levels for the SEDAR 33 benchmark assessment.

#### 5. Conclusions

Overall the main stock assessment results of the SEDAR 33 update model were similar to the SEDAR 33 benchmark assessment. The results of the jitter analysis for the update model were improved from those of the benchmark assessment with the update model appearing more stable than the previous benchmark assessment. Retrospective model results for the update model suggested no strong retrospective patterns were evident. In addition, the retrospective results for the update model indicate that the management advice with respect to  $SSB$  and stock status was not underestimated in the SEDAR 33 benchmark assessment. The update model predicts the greater amberjack stock is still overfished and undergoing overfishing as predicted by the benchmark assessment. However, the update assessment was somewhat more pessimistic with regard to stock status. The update assessment produced lower estimates of  $SSB/SPR_{30}$  and higher estimates of  $F/SPR_{30}$  in the most recent years.

Quota overages have occurred in both the commercial and recreational fisheries since implementation. Large commercial overages occurred in 2009, 2010, and 2012 in the commercial sector and in 2009, 2015, and 2016 in the recreational sector in 2009, 2013, 2015, and 2016. The updated commercial CPUE indices suggested a change in catchability around 2009 however practically speaking no definitive explanation is available. The opposite trend in CPUE was predicted for the longline fleet.

## 6. References

GARM 2008. Working paper 4.1. Report of the retrospective working group. GARM 2008 Methods Meeting, Woods Hole, MA. 25-29 February 2008. 34pp.

GMFMC 2008. Final Reef Fish Amendment 30A: Greater Amberjack - Revise rebuilding plan, accountability measures. Gray Triggerfish - Establish rebuilding plan, end overfishing, accountability measures, regional management, management thresholds and benchmarks. Including Supplemental Environmental Impact Statement, Regulatory Impact Review, and Regulatory Flexibility Act Analysis. February 2008. 346 p. Available online at: <http://gulfcouncil.org/docs/amendments/Amend-30A-Final%202008.pdf>.

Lo, N. C. H., L.D. Jacobson, and J.L. Squire. 1992. Indices of relative abundance from fish spotter data based on delta-lognormal models. *Can. J. Fish. Aquat. Sci.* 49: 2515-1526.

McCarthy, K. 2011. Calculated discards of yellowtail snapper from commercial vertical line fishing vessels in southern Florida. SEDAR22-RD02. SFD-2011-016.

Mackerel Stock Assessment Panel. 1990. 1990 Report of the Mackerel Stock Assessment Panel. MIA 89/90-07. MIA

McClellan, D.B, and N.J. Cummings. 1996. Stock assessment of Gulf of Mexico greater amberjack through 1995. U.S. Dept. of Comm., NOAA, NMFS, SEFSC, Miami Lab. Contr. No. MIA-96/97-03.70p.

Methot, R.D. and Taylor, I.G., 2011. Adjusting for bias due to variability of estimated recruitments in fishery assessment models. *Can. J. Fish. Aquat. Sci.*, 68:1744-1760.

Mohn, R. 1999. The retrospective problem in sequential population analysis: An investigation using cod fishery and simulated data. *ICES J. Mar. Sci.* 56: 473-488.

Parrack, N.C. 1993. The exploitation status of Atlantic amberjack fisheries through 1991. U.S. Dept. of Com., NOAA, NMFS, SEFSC, Miami Laboratory Cont. No. MIA-92.93-30. 98p.

SEDAR. 2006. Stock Assessment Report 2: Gulf of Mexico Greater Amberjack. SEDAR, North Charleston, SC. Available online at: [http://sedarweb.org/docs/sar/SEDAR9\\_SAR2%20GOM%20GreaterAmberjack.pdf](http://sedarweb.org/docs/sar/SEDAR9_SAR2%20GOM%20GreaterAmberjack.pdf)

SEDAR. 2011. SEDAR 9 Stock Assessment Update Report: Gulf of Mexico Greater Amberjack. , SEDAR. North Charleston, SC. Available online at: <http://sedarweb.org/2010-update-sedar-09-gulf-mexico-greater-amberjack>

SEDAR. 2009. Stock assessment of Greater Amberjack in the Gulf of Mexico: SEDAR 9 update assessment. SEDAR, North Charleston, SC.

SEDAR. 2016. SEDAR Data Best Practices: Living Document – September 2016. SEDAR, North Charleston SC. 115 pp. available online at: <http://sedarweb.org/sedar-data-best-practices>.

Turner, S.C., N.J. Cummings, and C.E. Porch. 2000. Stock assessment of Gulf of Mexico greater amberjack using data through 1998. NMFS/SEFSC, Miami Laboratory. Document SFD 99/00-100. 28p.

## **7. Acknowledgements**

The SEDAR 33 greater amberjack stock assessment was conducted through the collaborative efforts of numerous fisheries experts across multiple agencies. The following agencies contributed to the Update assessment and deserve notable attention and thanks for efforts extended to update data and clarify a variety of questions relating to updating the data inputs: NOAA, SEFSC, Fisheries Statistics Division (FSD); SEFSC, Panama City Laboratory, SEFSC Galveston Laboratory; SEFSC, Beaufort Laboratory; University of Florida, Gulf States Marine Fisheries Commission. The document was improved through the internal SEFSC, Sustainable Fisheries editorial review process

## **8. Tables**

## **9. Figures**

## **10. Appendices**

- 10.1. Appendix A.**
- 10.2. Appendix B.**
- 10.3. Appendix C.**
- 10.4. Appendix D.**
- 10.5. Appendix E.**

## 8. Figures

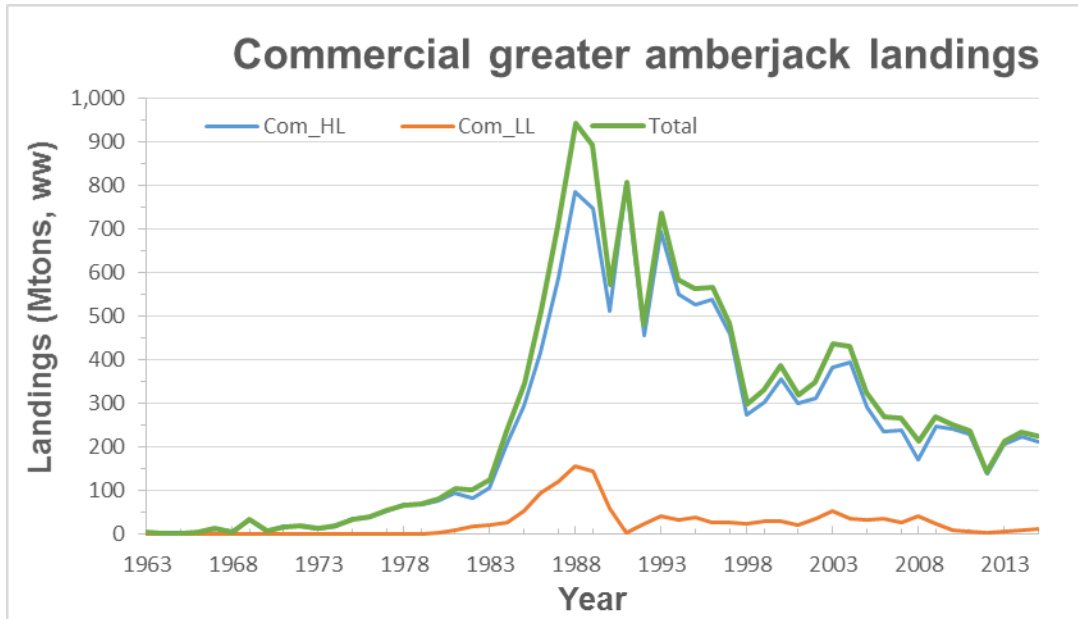


Figure 1. Commercial landings of Gulf of Mexico greater amberjack (MTons, whole weight) from the SEDAR 33 update assessment.

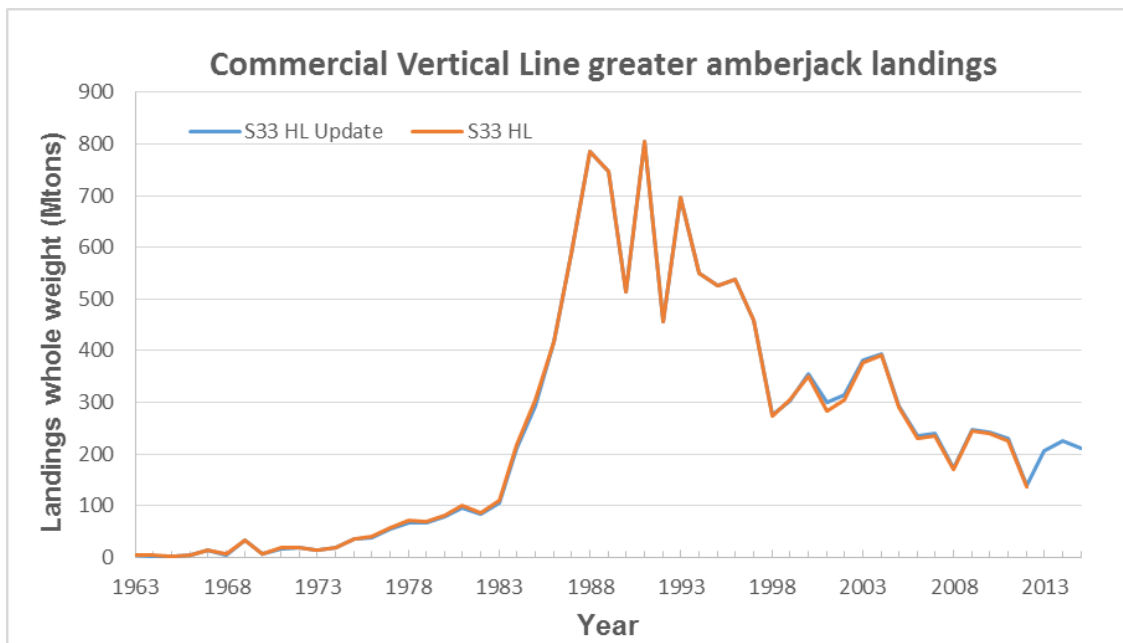


Figure 1. Comparison of the commercial vertical line greater amberjack landings from the SEDAR 33 update and SEDAR 33 benchmark assessments.



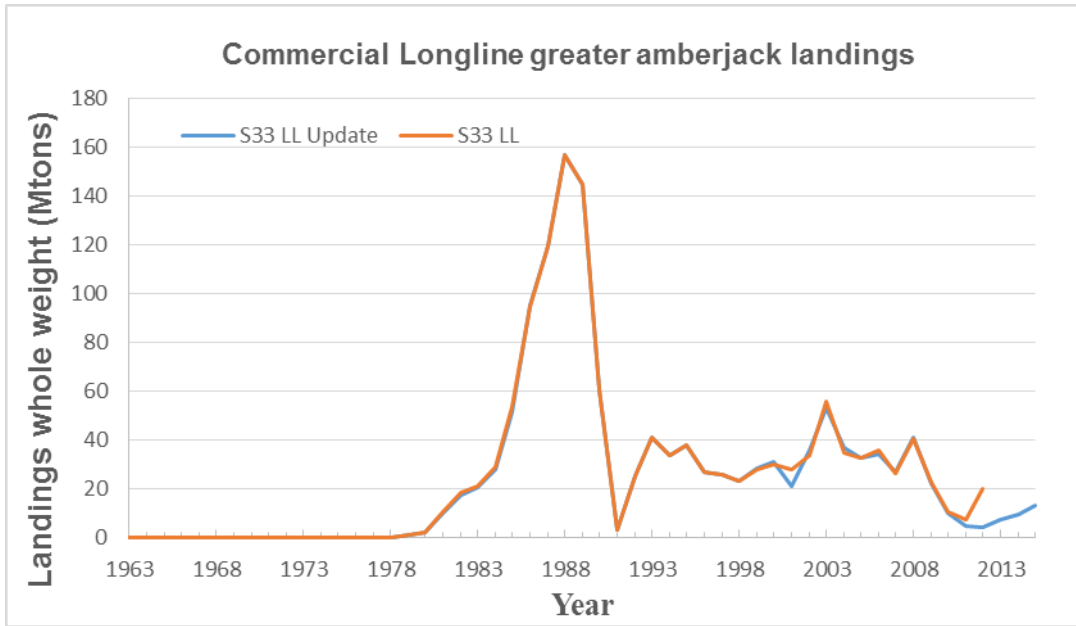


Figure 2. Comparison of the commercial longline greater amberjack landings from the SEDAR 33 update and SEDAR 33 benchmark assessments.

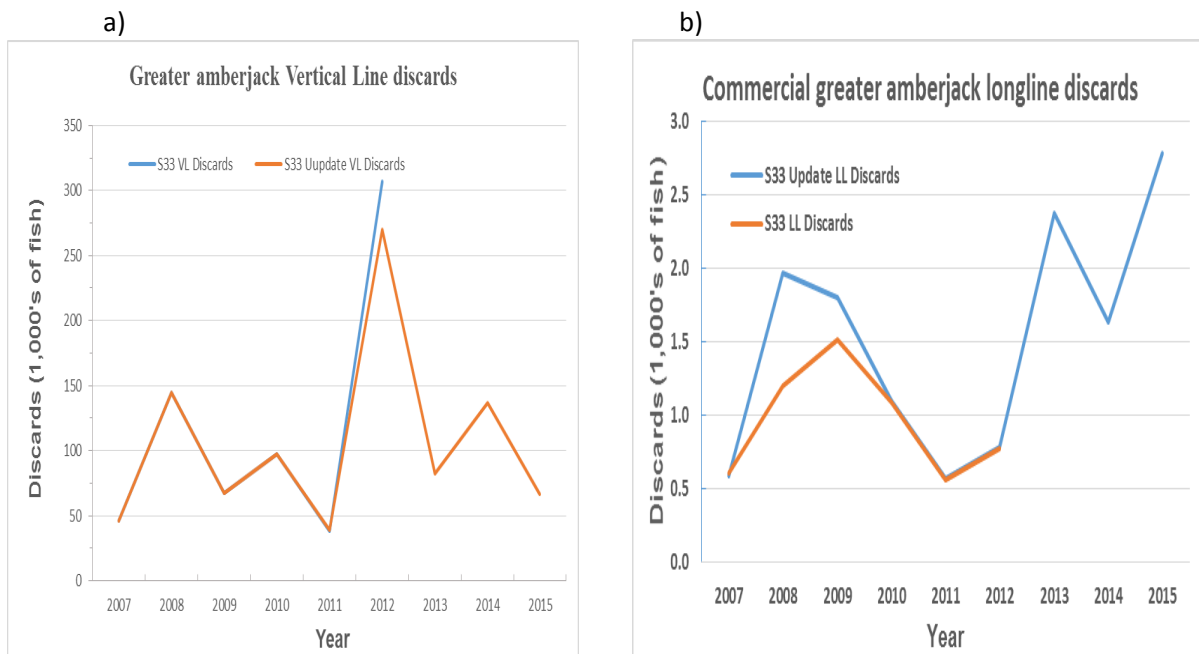


Figure 4a. Comparison of commercial greater amberjack discards: a) vertical line and b) longline for the SEDAR 33 update and SEDAR 33 benchmark assessment.

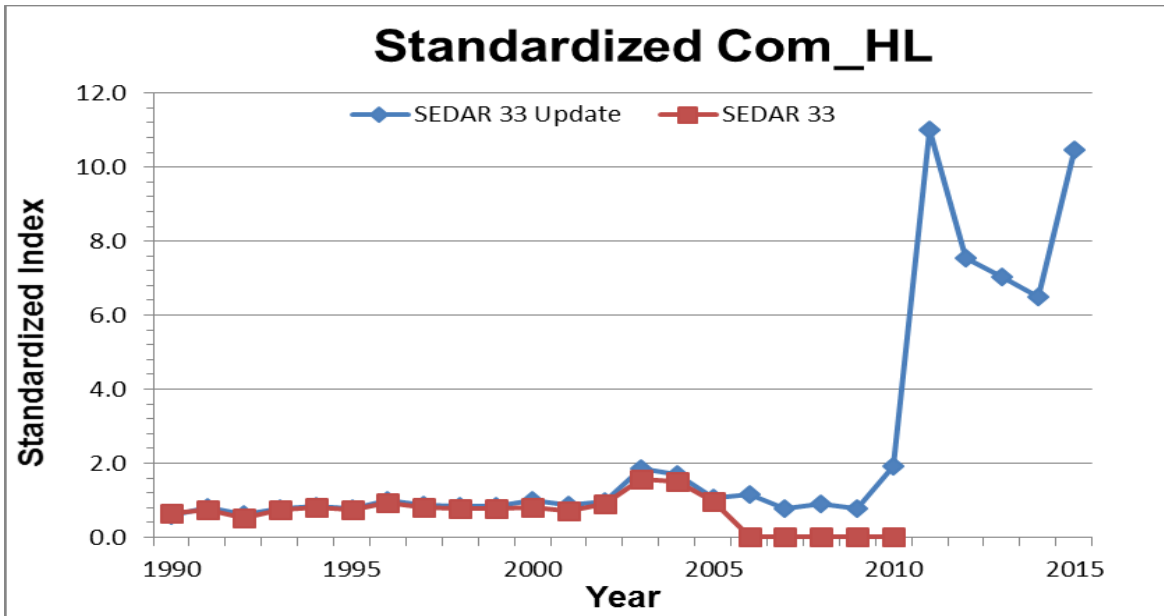


Figure 5a. Standardized CPUE for the greater amberjack commercial hand line fishery (Com\_HL fleet) for the SEDAR 33 update and SEDAR 33 benchmark assessments.

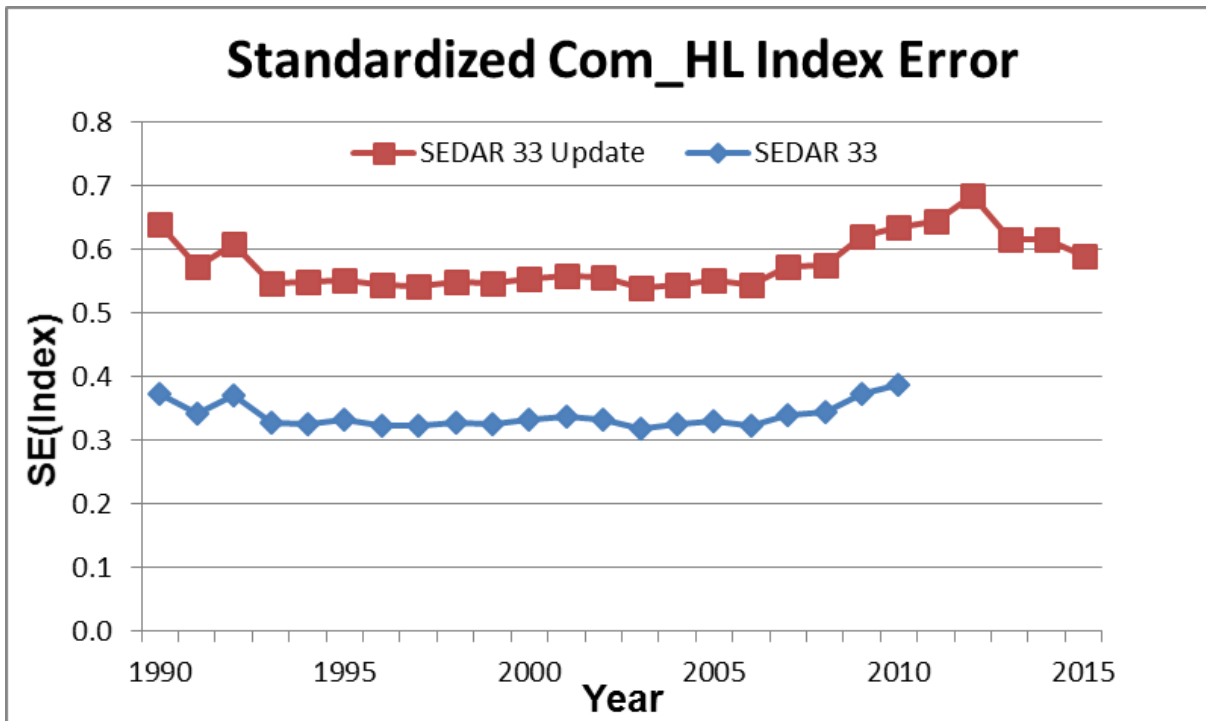


Figure 5b. Standard error of standardized CPUE for greater amberjack commercial longline fishery (Com\_LL) fleet for the SEDAR 33 update and SEDAR 33 benchmark assessments.

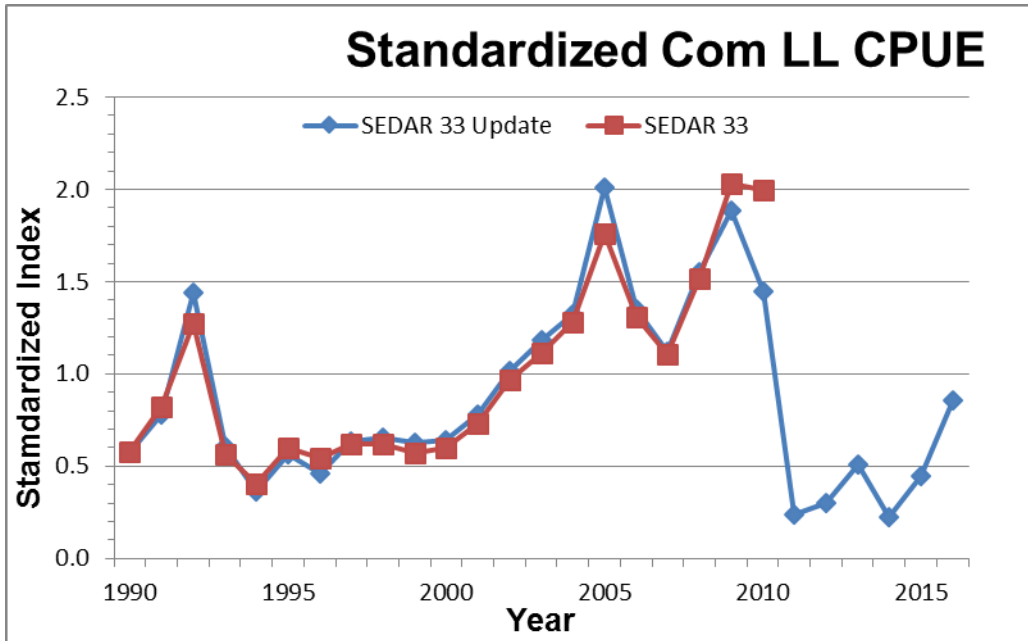


Figure 5c. Standardized CPUE for the greater amberjack commercial longline fishery (Com\_LL fleet) for the SEDAR 33 update and SEDAR 33 benchmark assessments.

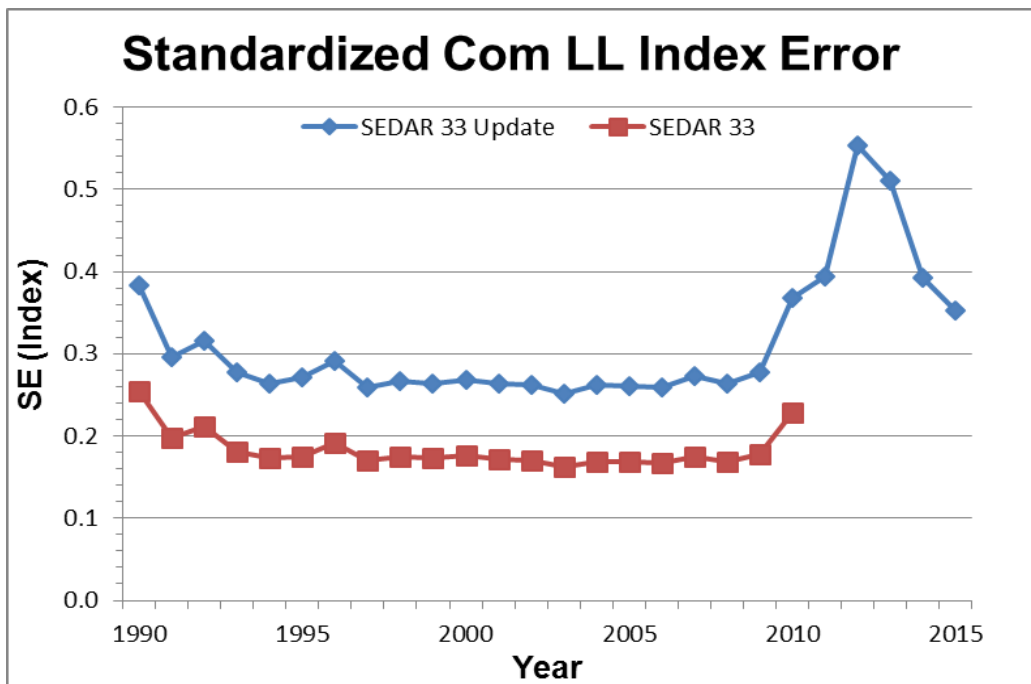
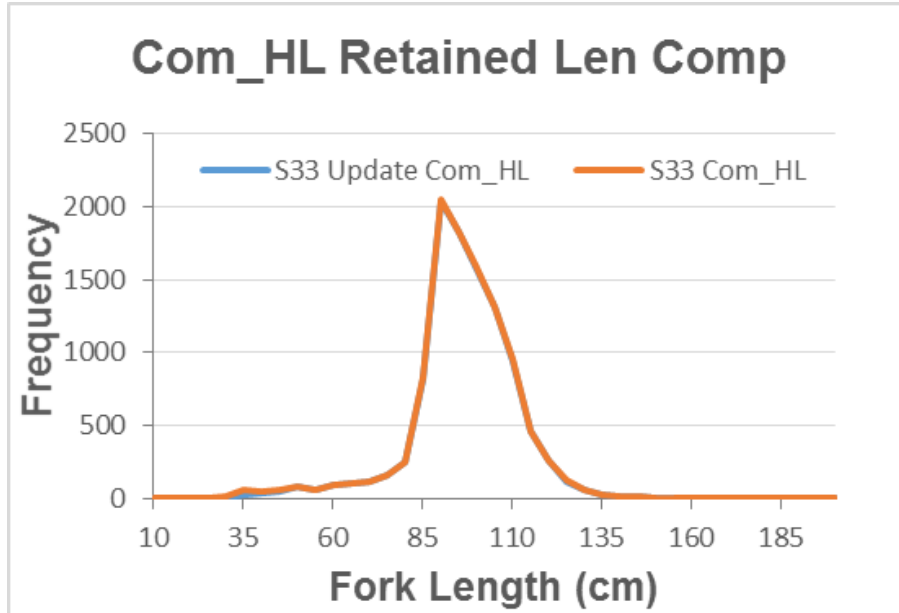


Figure 5d. Standard error of standardized CPUE for the greater amberjack commercial longline fishery (Com\_LL) fleet) for the SEDAR 33 update and SEDAR 33 benchmark assessments.

a)



b)

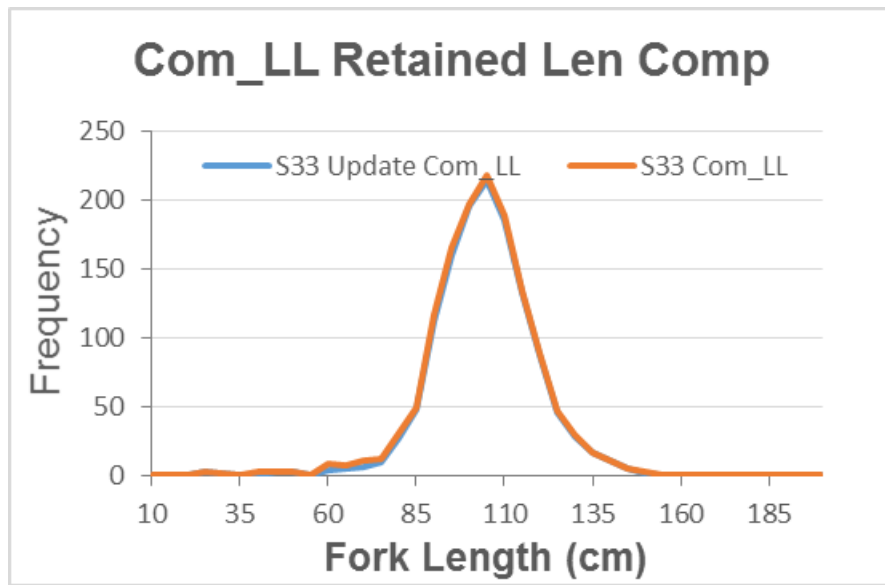
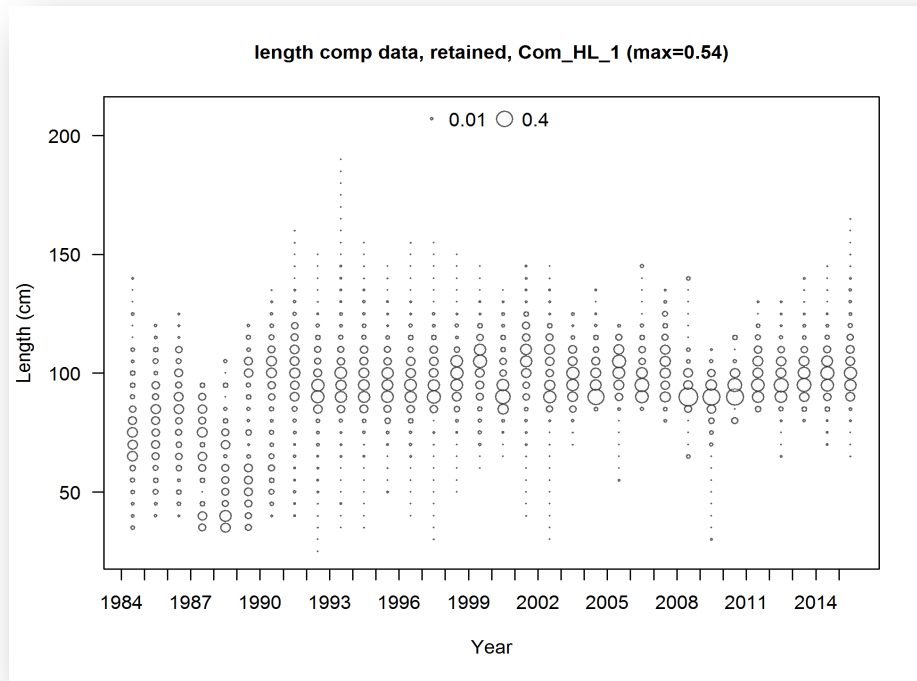


Figure 6. Length composition data of retained catch from the greater amberjack commercial a) vertical line and b) longline fleets for the SEDAR 33 update and the SEDAR 33 benchmark assessments. The figures do not include data from 2013-2015.



b)

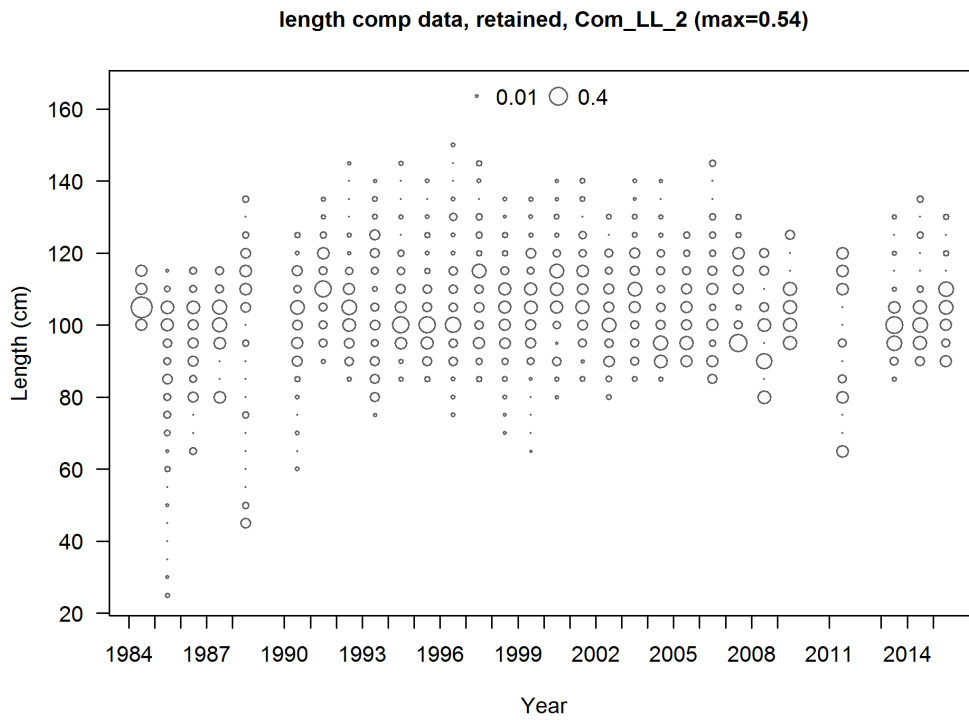
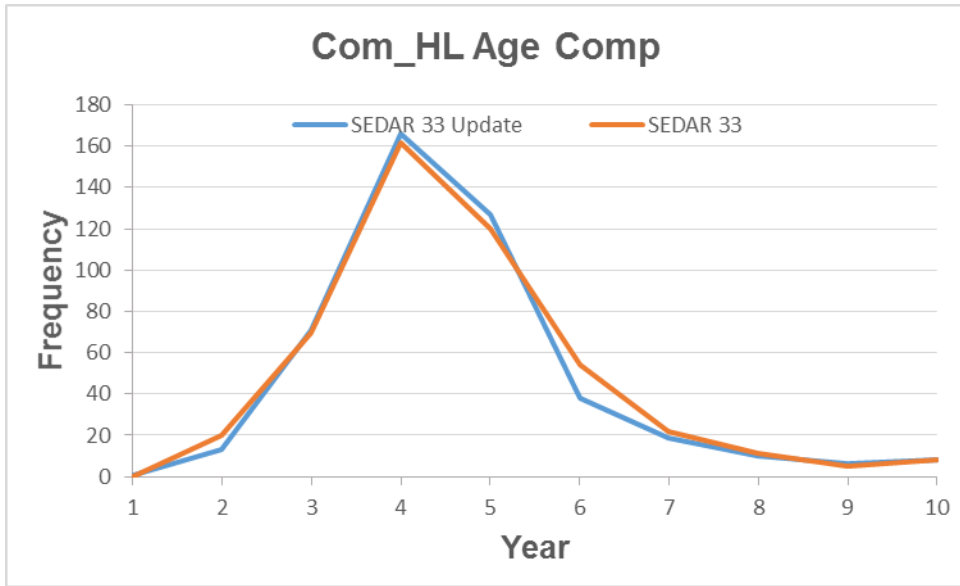


Figure 7. Annual length composition of greater amberjack retained catch from the commercial a) vertical line and b) longline fleets for the SEDAR 33 update assessment model. Size limits were implemented in 1990 (36 inches FL, 91.44 cm FL).



b)

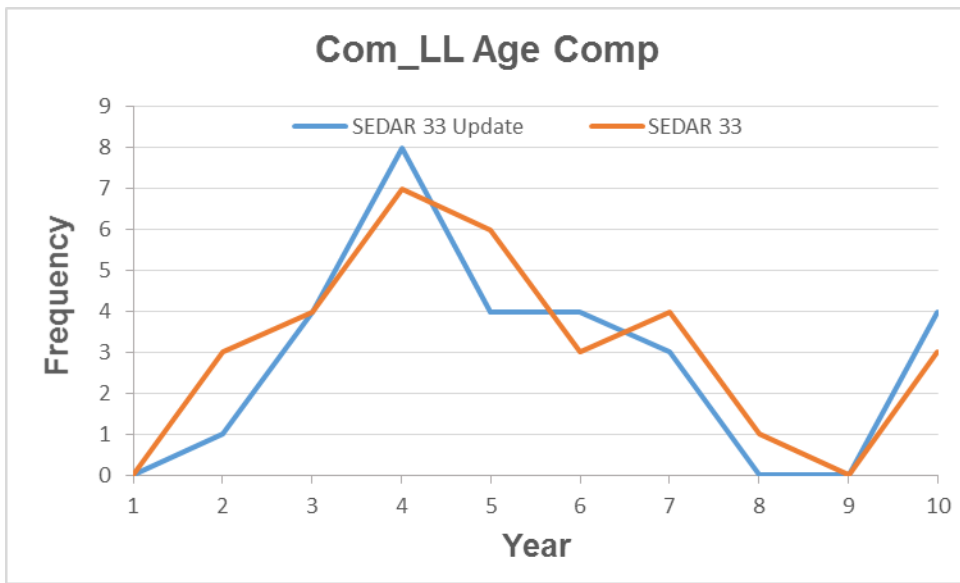
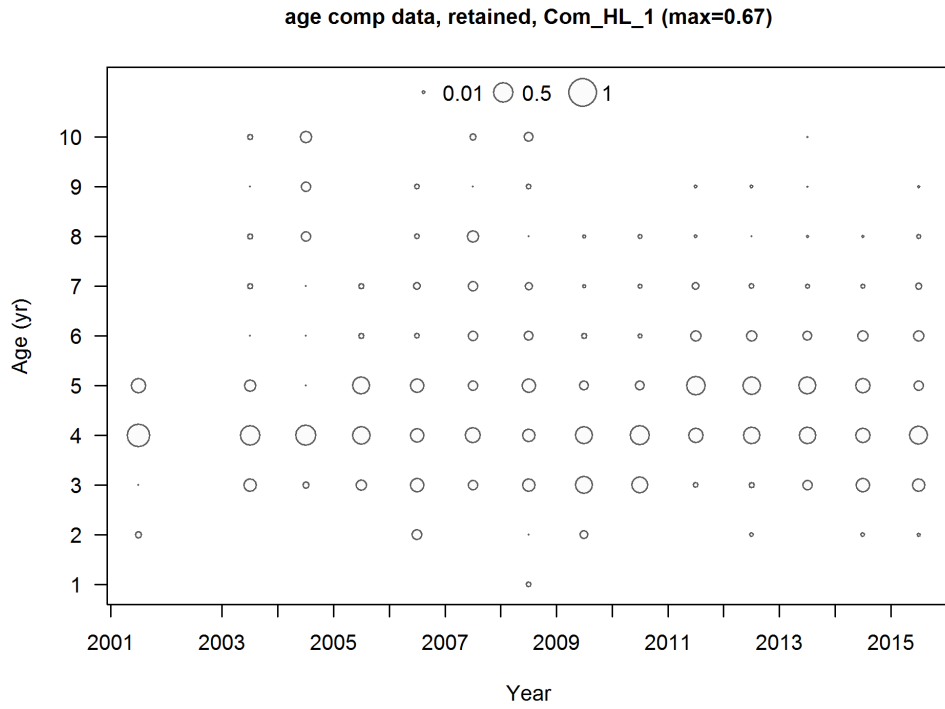


Figure 3. Age composition data of greater amberjack retained catch from the commercial a) vertical line and b) longline fleets for the SEDAR 33 update and the SEDAR 33 benchmark assessments. The figures do not include data from 2013-2015.

a)

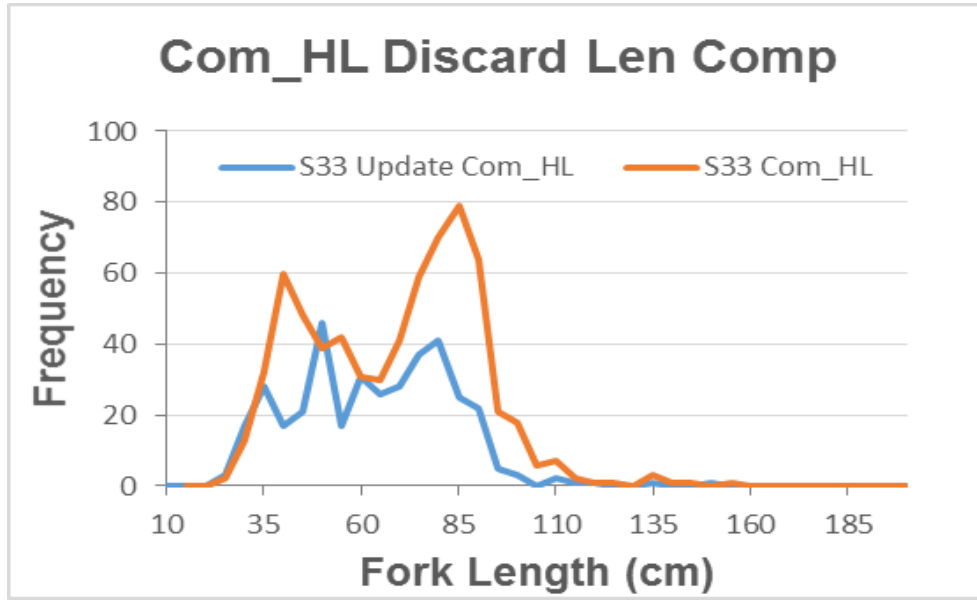


b)



Figure 4. Annual age composition data from greater amberjack commercial a) vertical line and b) longline retained catch for the SEDAR 33 update model.

a)



b)

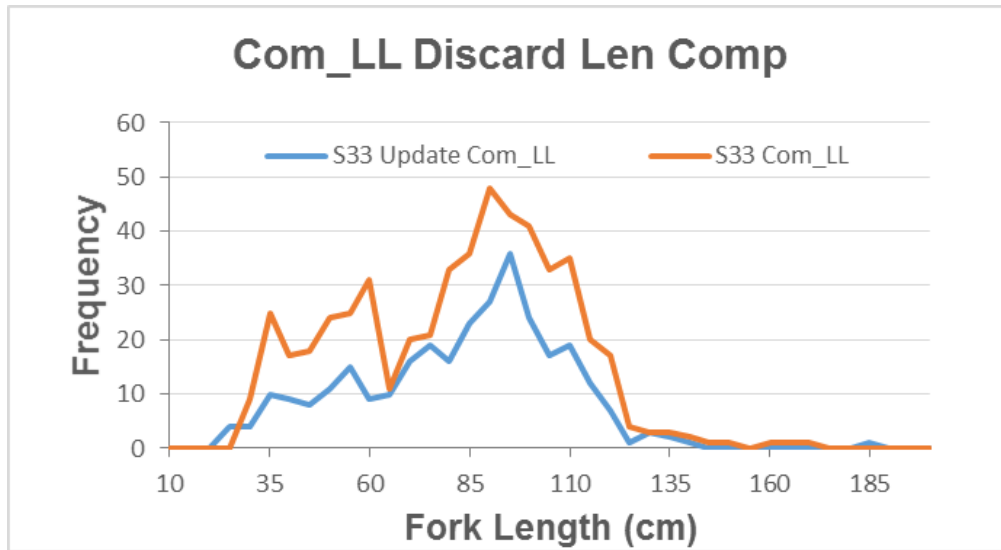
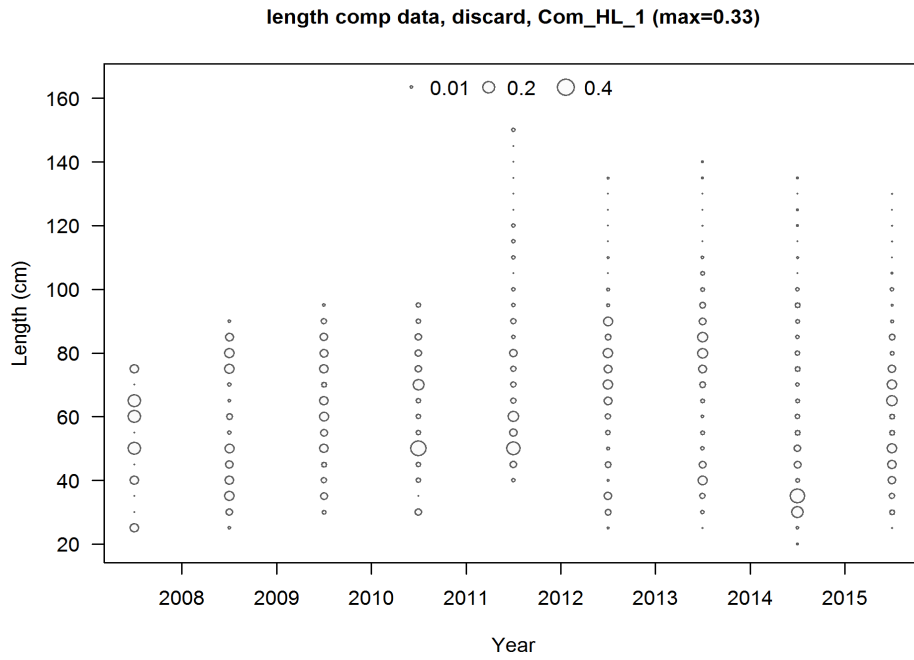


Figure 10. Length composition data of discarded greater amberjack from the commercial: a) vertical line and b) longline fleets for SEDAR 33 update and the SEDAR 33 benchmark assessments. The figures do not include data from 2013-2015.



a)



b)

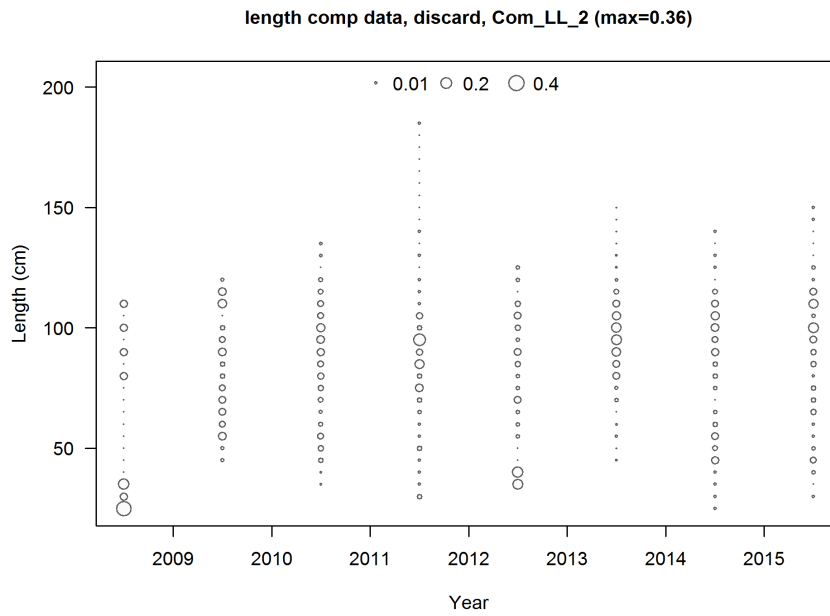


Figure 11. Annual length composition of discarded greater amberjack from the commercial a) vertical line and b) longline fleets for the SEDAR 33 update model.

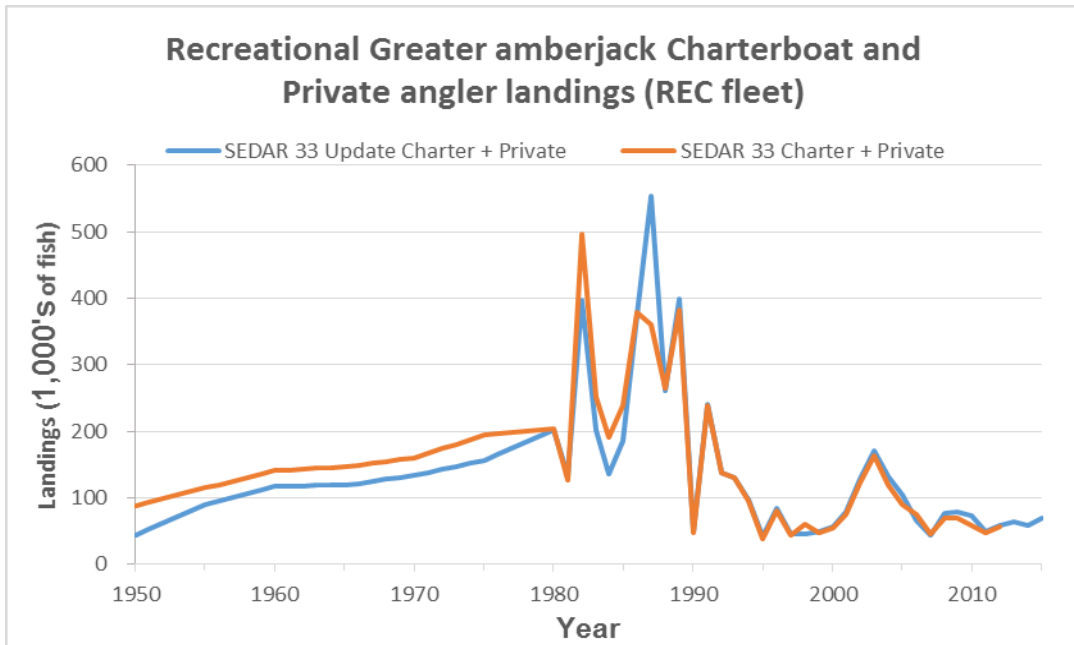


Figure 12. Recreational landings greater amberjack for the charterboat and private angler fisheries (REC fleet) for the SEDAR 33 update and SEDAR 33 benchmark assessment.

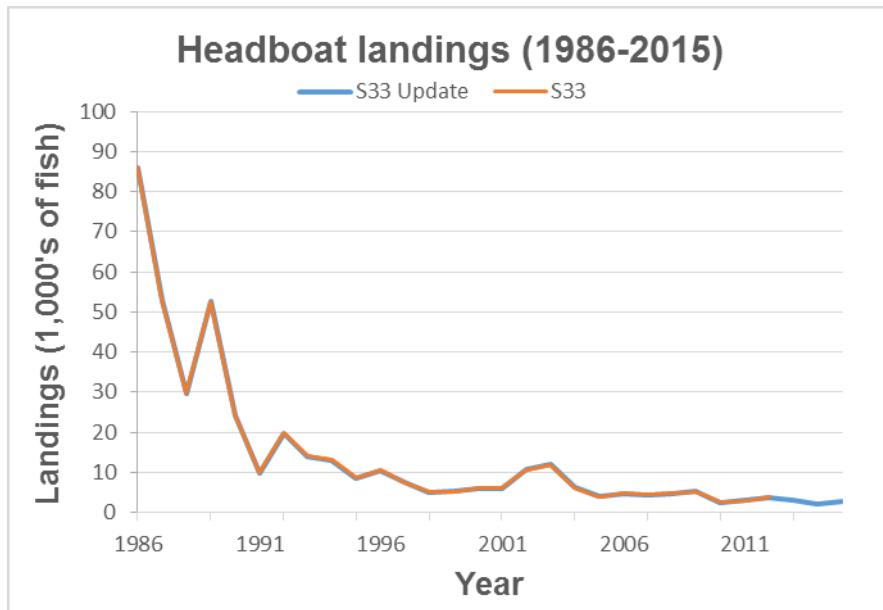


Figure 13. Recent period (1986-2015) landings of greater amberjack by the headboat fleet for the SEDAR 33 update assessment and the SEDAR 33 benchmark. **Historic headboat landings for SEDAR 33 update are presented in Table 3b.**

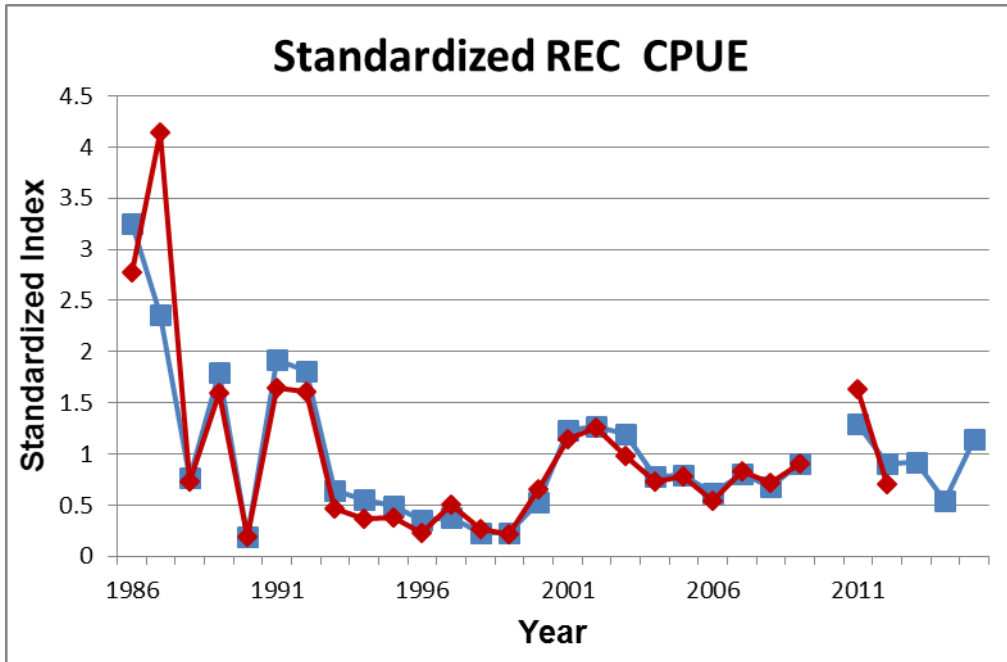


Figure 14a. Standardized REC CPUE for the recreational charterboat and private angler fishery (REC fleet) for the SEDAR 33 update and SEDAR 33 benchmark assessment for greater amberjack.

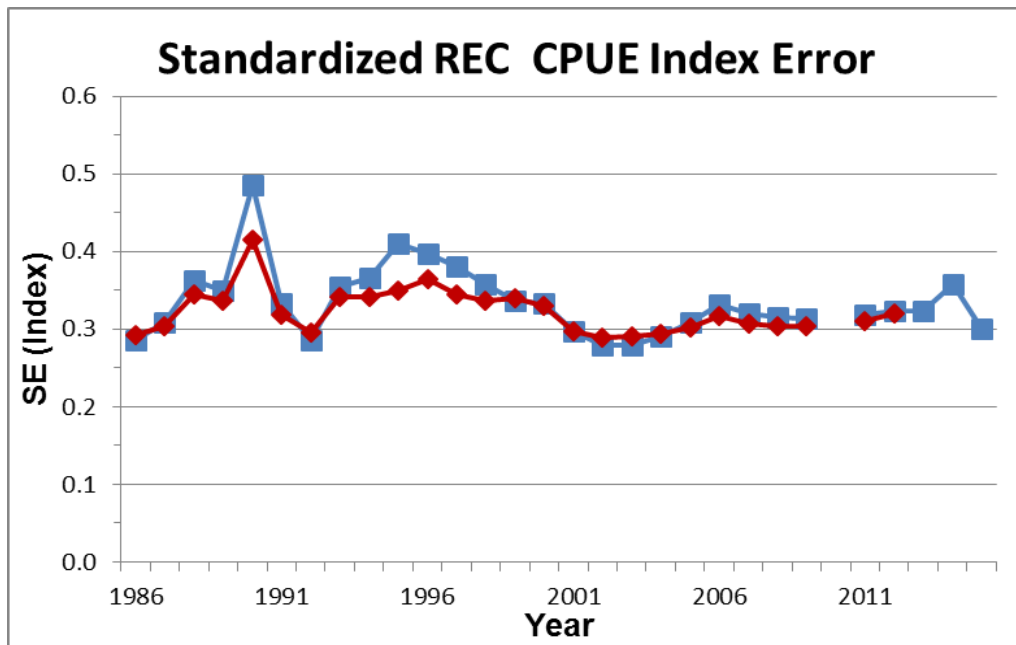


Figure 14b. Standard error of REC CPUE for the recreational charterboat and private angler fishery (REC fleet) for the SEDAR 33 update and SEDAR 33 benchmark assessment for greater amberjack.

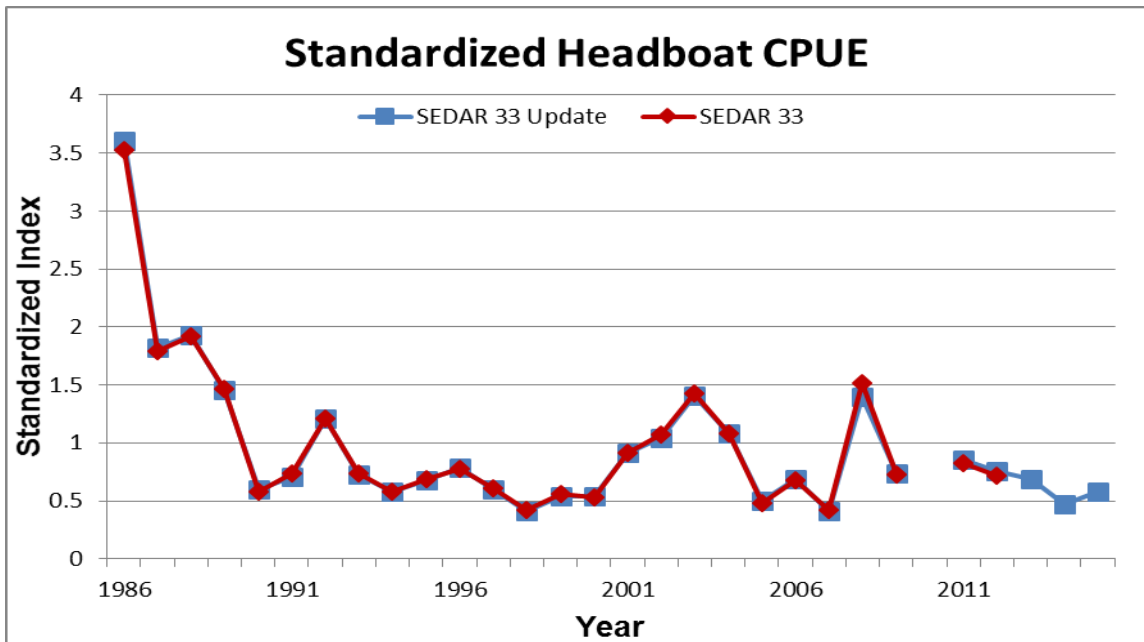


Figure 14c. Standardized REC CPUE for the recreational headboat fishery and private angler fishery (Headboat fleet) for the SEDAR 33 update and SEDAR 33 benchmark assessment for greater amberjack.

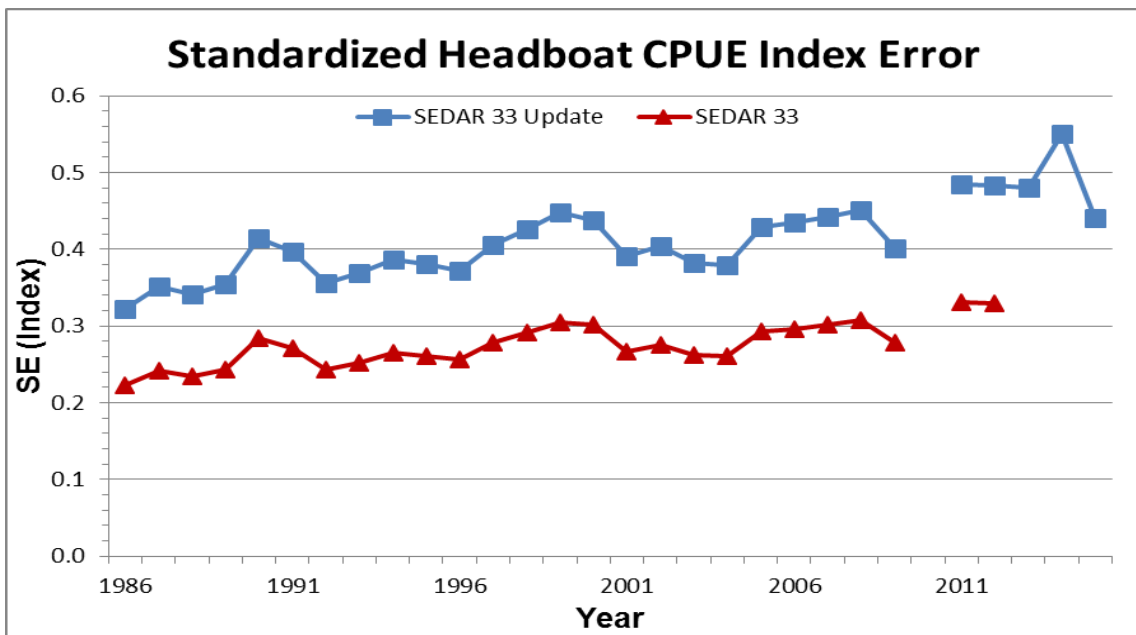


Figure 14d. Standard error of REC CPUE for the recreational headboat fishery and private angler fishery (Headboat fleet) for the SEDAR 33 Update and SEDAR 33 benchmark assessment for greater amberjack.

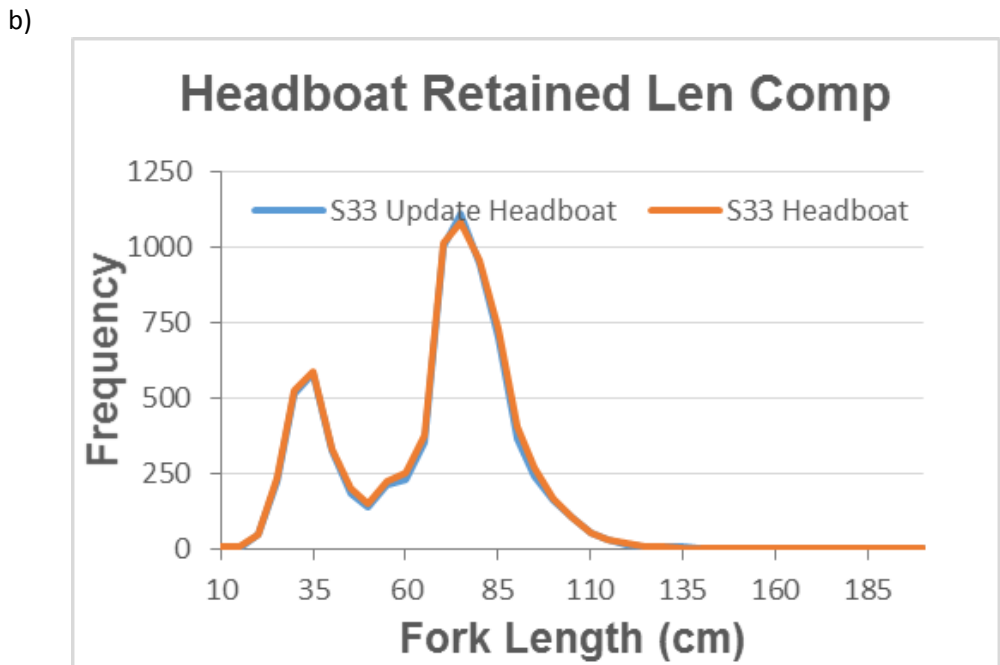
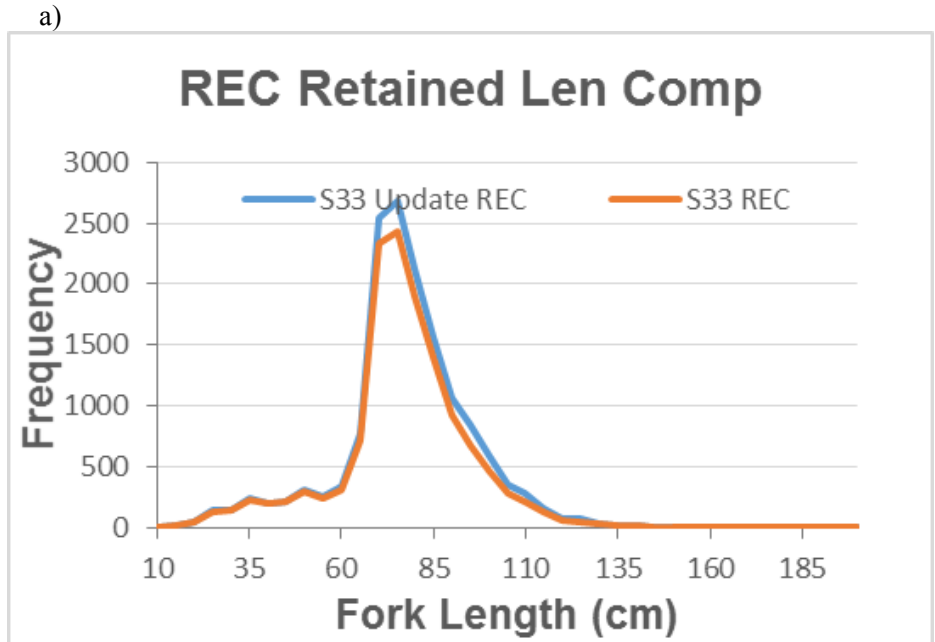
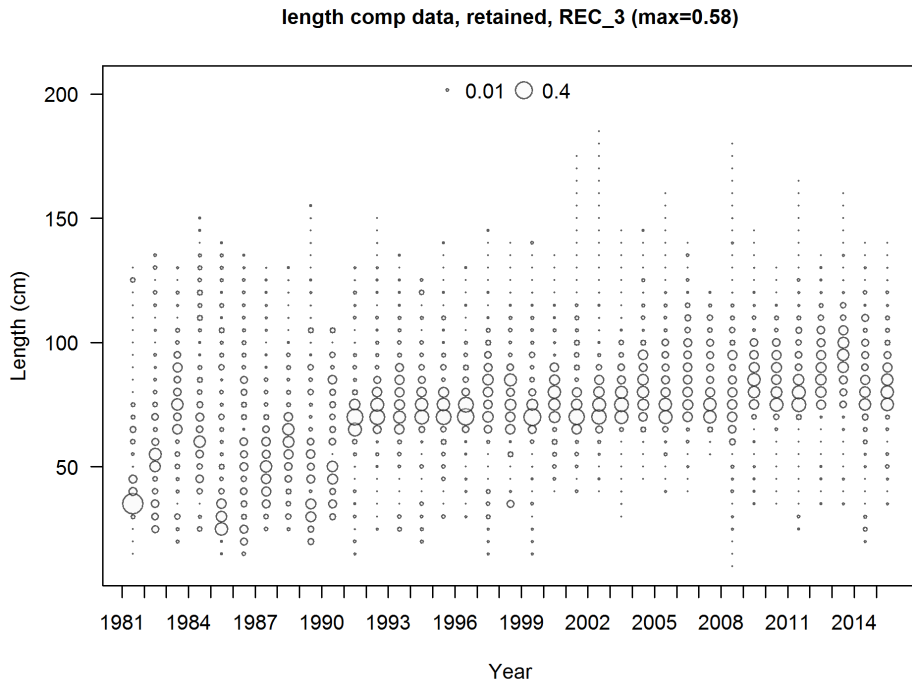


Figure 15. Length composition data of greater amberjack retained catch from the commercial a) vertical line and b) longline fleets for the SEDAR 33 update and SEDAR 33 benchmark assessments for. The figures do not include data from 2013-2015.

a)



b)

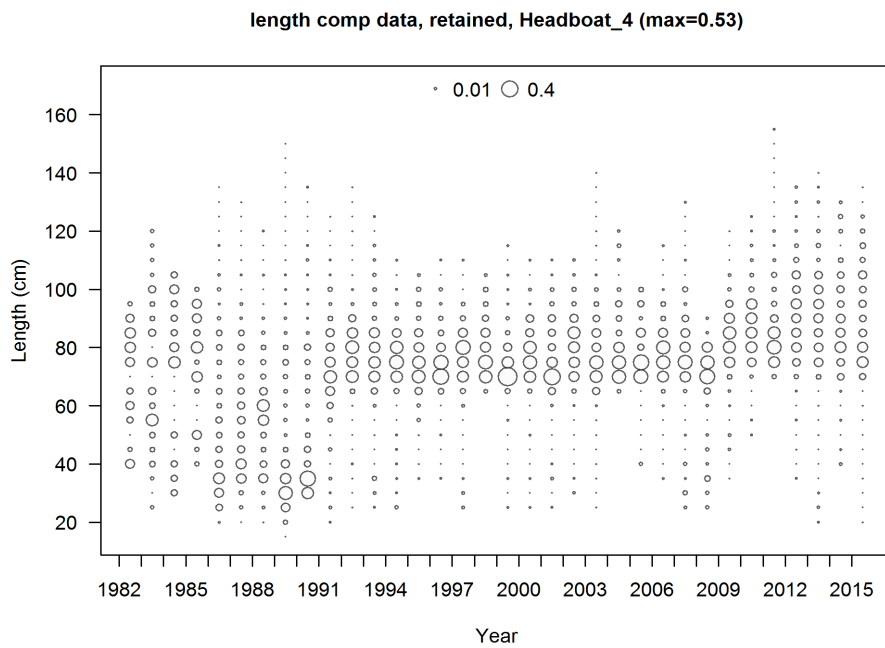
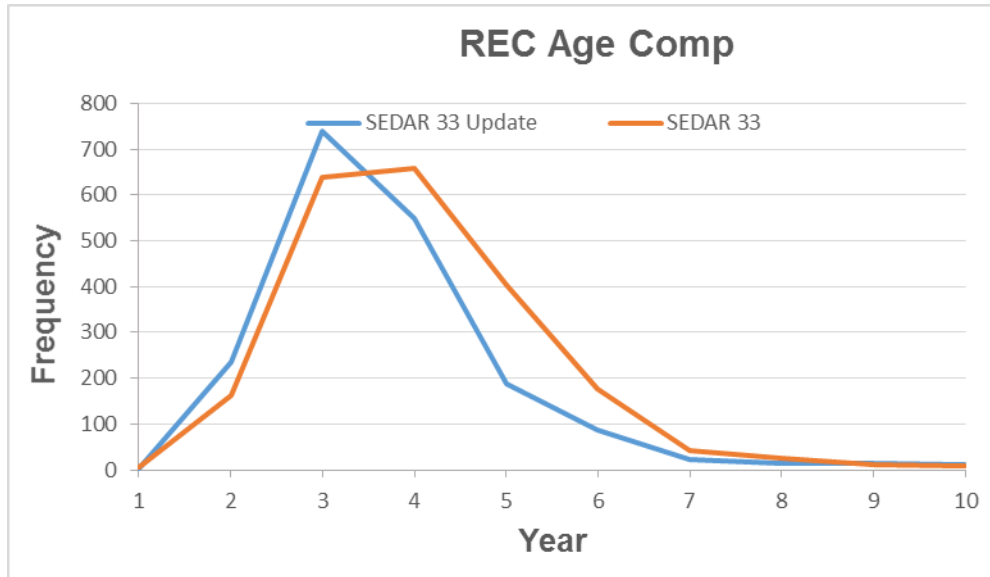


Figure 16. Annual length composition of greater amberjack retained catch for the recreational a) charterboat and private angler (REC) and b) headboat fleets for the SEDAR 33 update assessment model. Size limits were implemented in 1990 (28 inches FL, 71.12 cm FL), 2008 (30 FL, 76.20 cm FL). The shift in retained catch size composition after ~ 1990 is due to size limits.

a)



b)

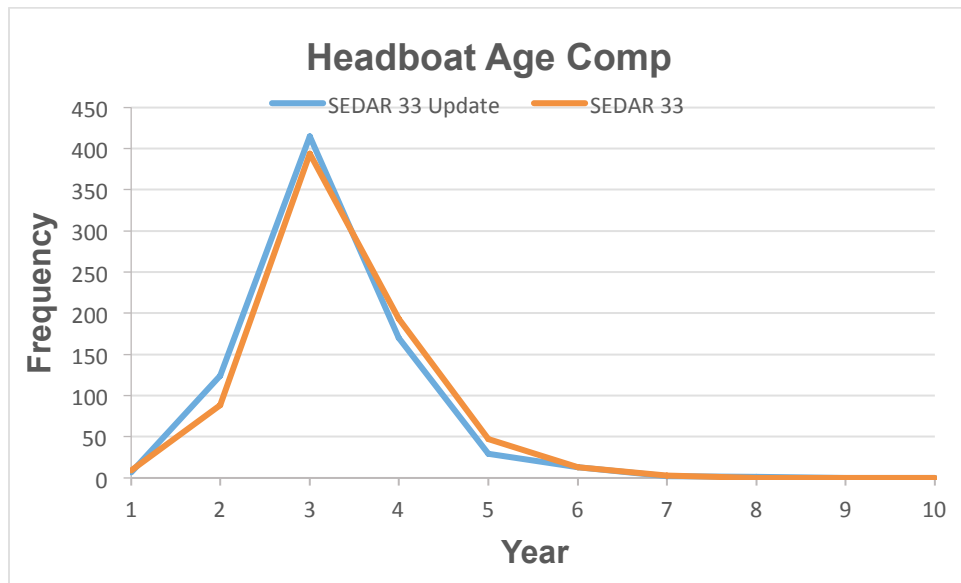
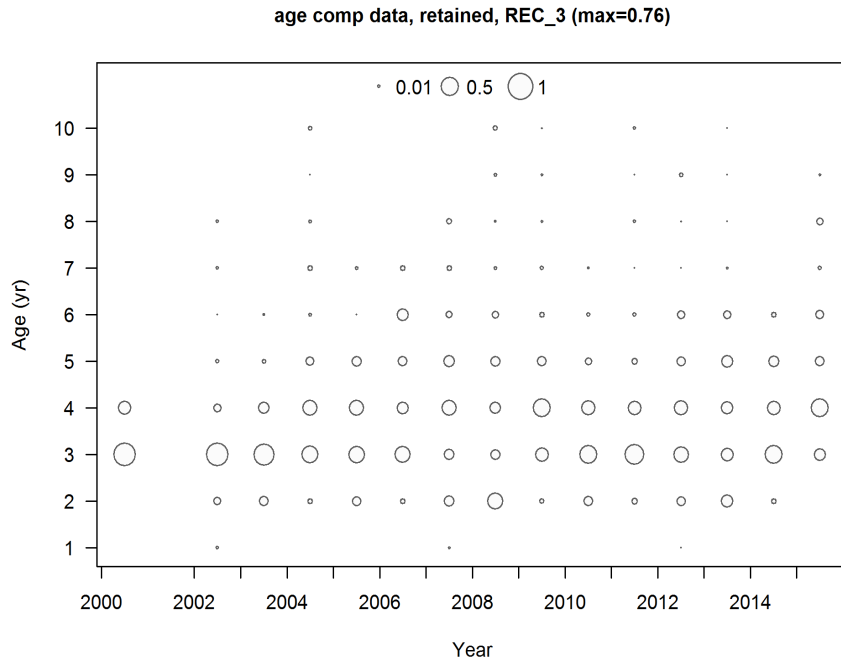


Figure 17. Age composition data of greater amberjack retained catch from the recreational a) charterboat and private angler (REC) and b) headboat fleets for the SEDAR 33 update and SEDAR 33 benchmark assessments. The figures do not include data from 2013-2015.

a)



b)

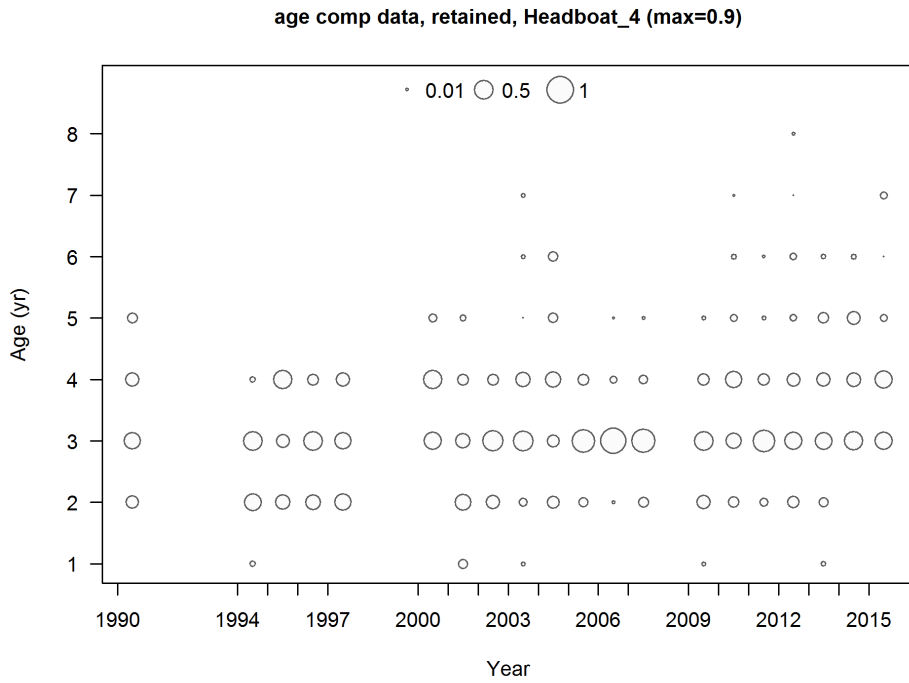
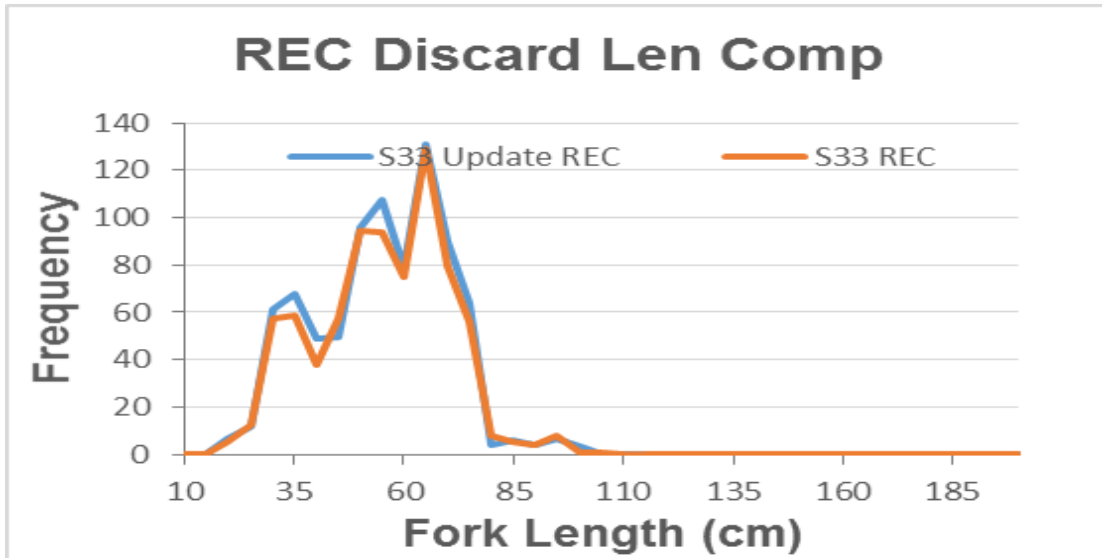


Figure 18. Annual greater amberjack age composition data from recreational a) charterboat and private angler (REC) and b) headboat fleets retained catch for the SEDAR33 update model.



a)



b)

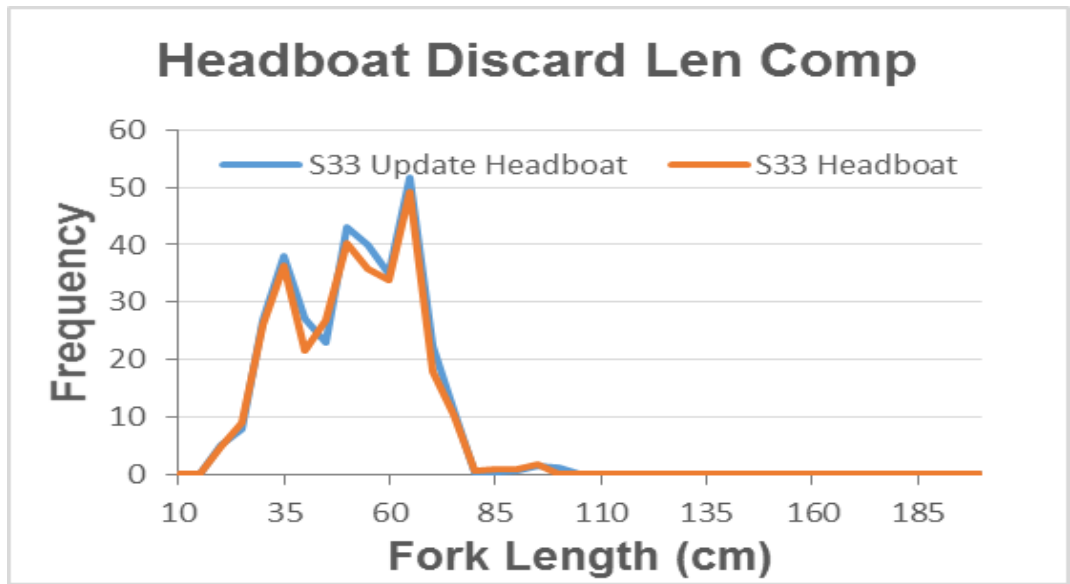
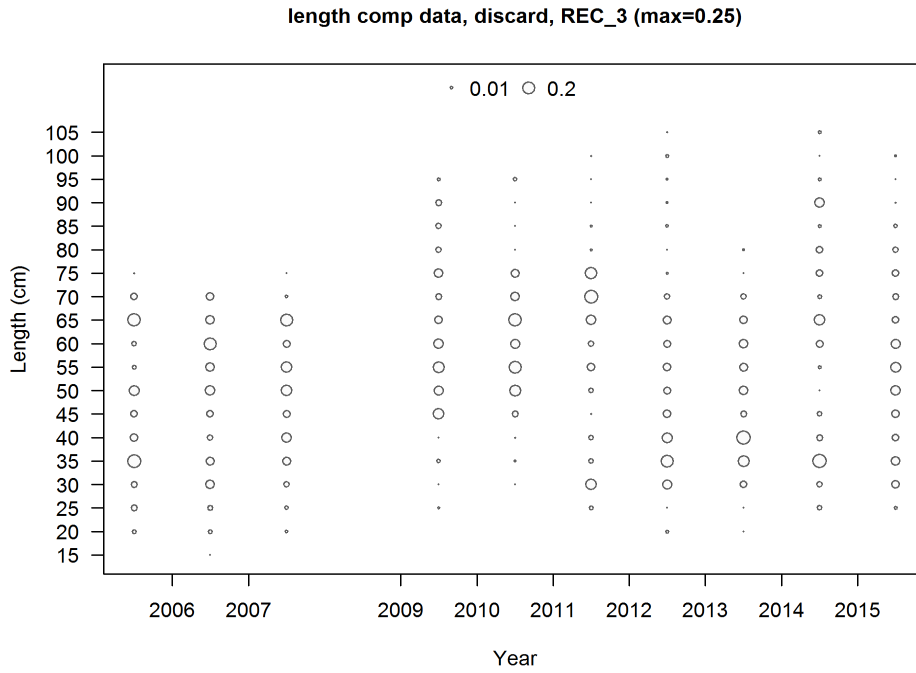


Figure 19. Length composition data of discarded greater amberjack from the recreational a) charterboat and private angler (REC) and b) headboat fleets for the SEDAR 33 update and SEDAR 33 benchmark assessments. The figures do not include data from 2013-2015.

a)



u

b)

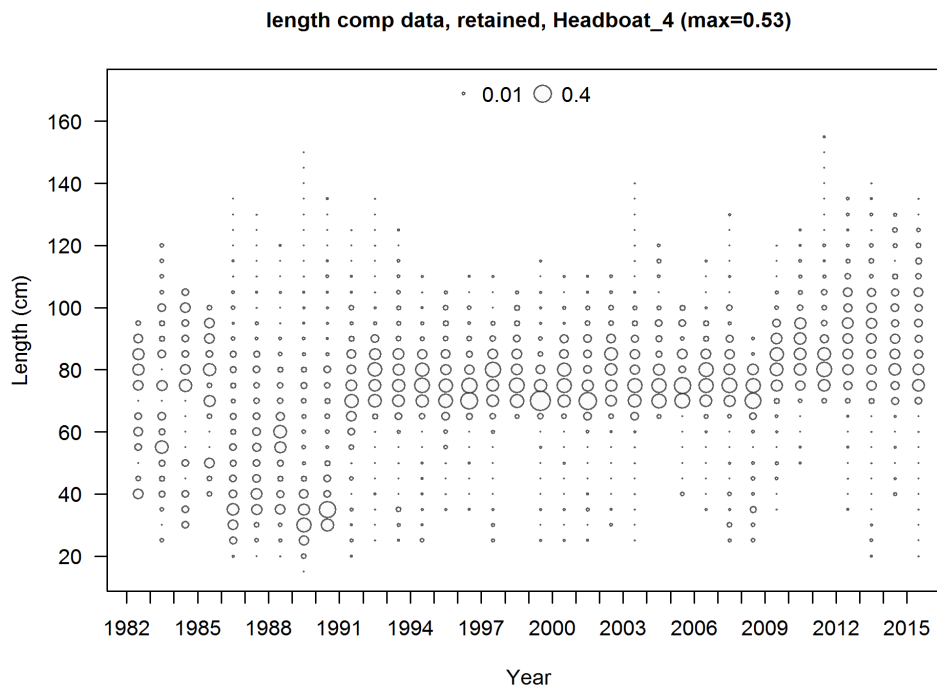


Figure 20. Annual length composition of discarded greater amberjack from the recreational a) charterboat and private angler fisheries (REC fleet) and b) headboat fisheries for the SEDAR 33 update model.

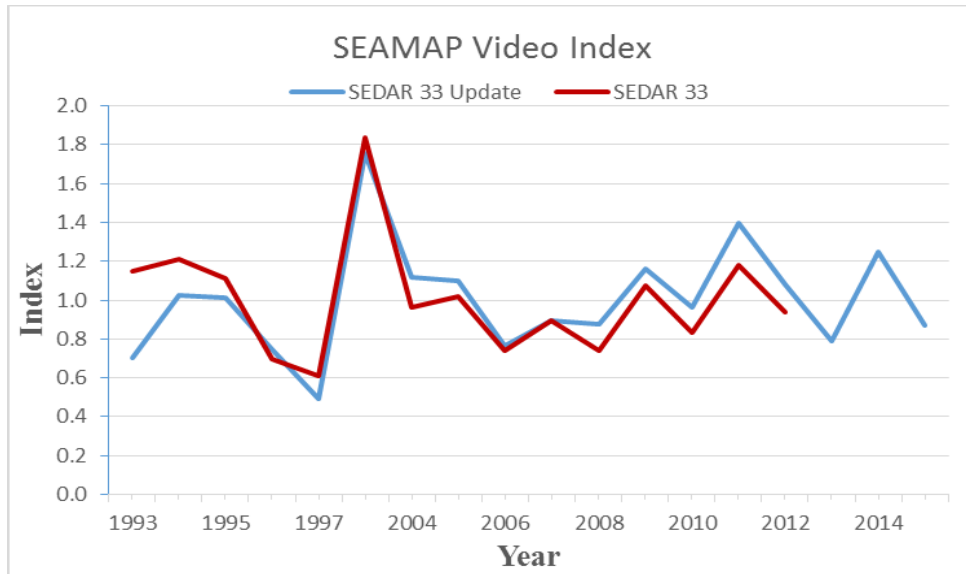


Figure 21a. Standardized CPUE for the SEAMAP Video Survey for the SEDAR 33 update and SEDAR 33 benchmark assessment for greater amberjack.

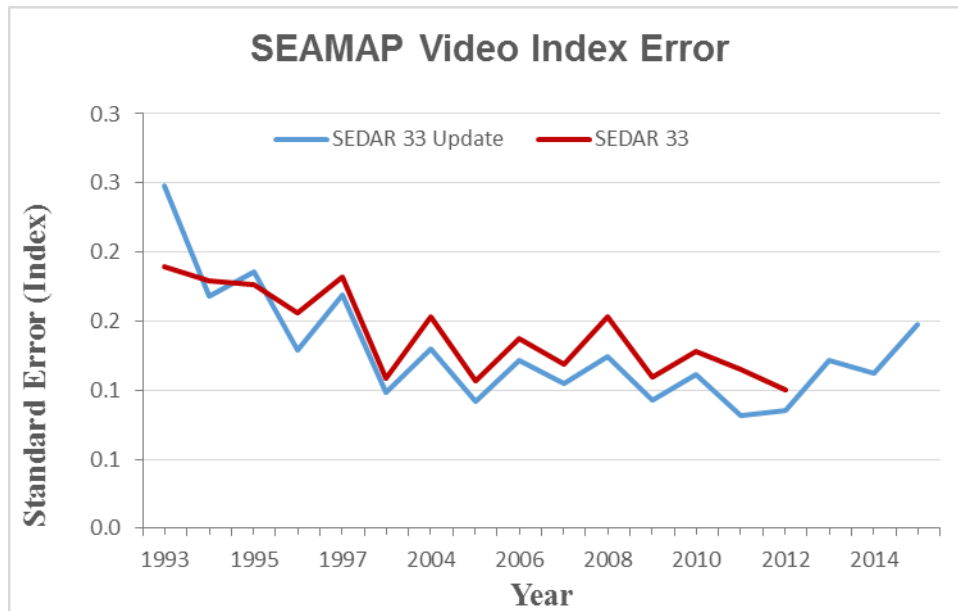


Figure 21b. Standard error of CPUE for the SEAMAP Video Survey for the SEDAR 33 update and SEDAR 33 benchmark assessment for greater amberjack.

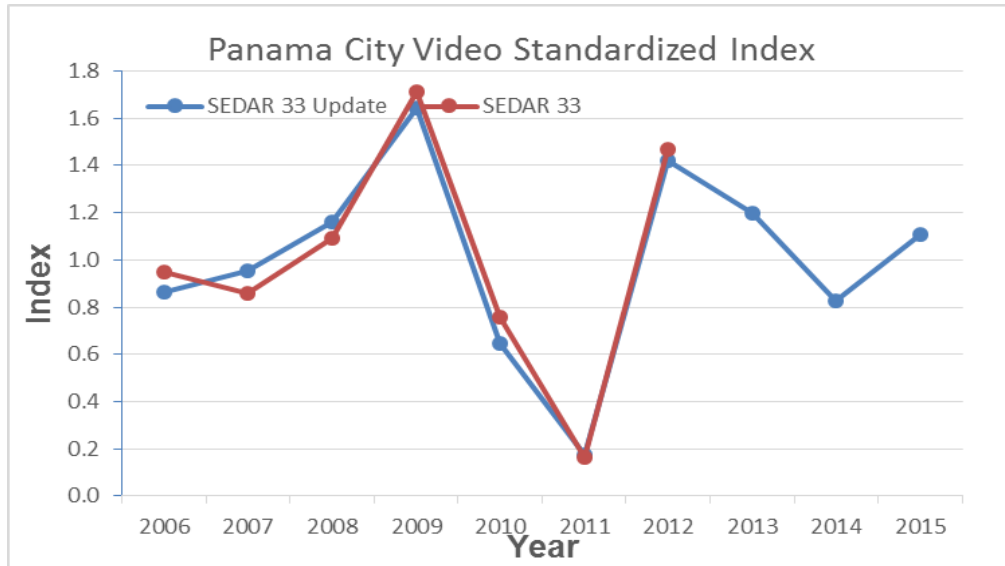


Figure 22a. Standardized CPUE for the Panama City Video Survey for the SEDAR 33 update and SEDAR 33 benchmark assessment for greater amberjack.

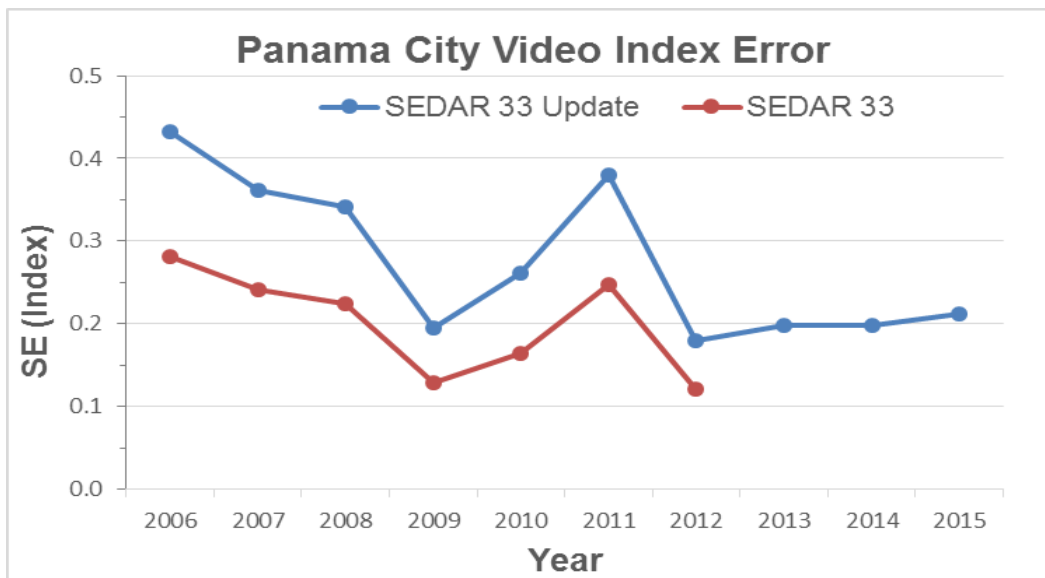


Figure 22b. Standard error of CPUE for the Panama City Video Survey for the SEDAR 33 update and SEDAR 33 benchmark assessment for greater amberjack.

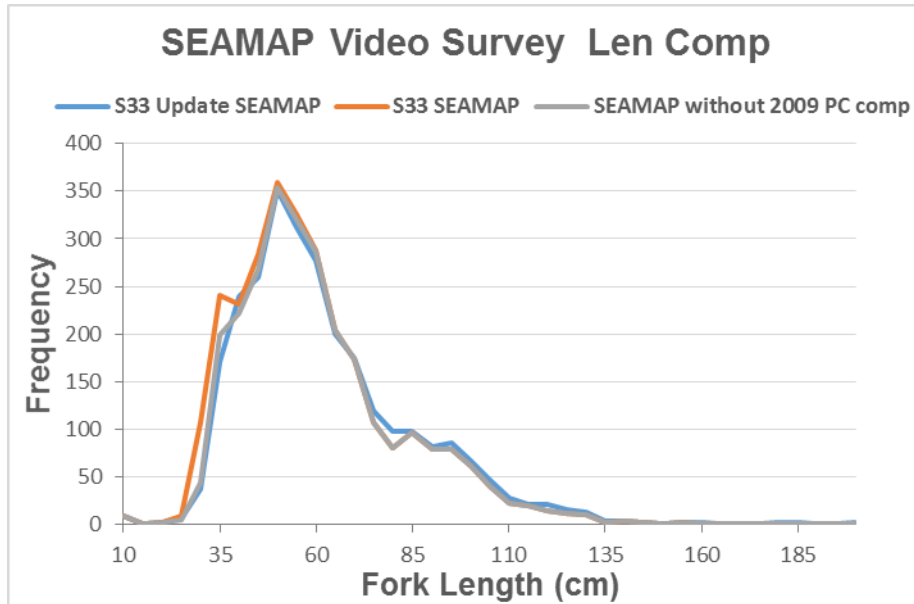


Figure 23. Length composition data of greater amberjack from the SEAMAP Video Survey for the SEDAR 33 update and SEDAR 33 benchmark assessments for. The figures do not include data from 2013-2015.

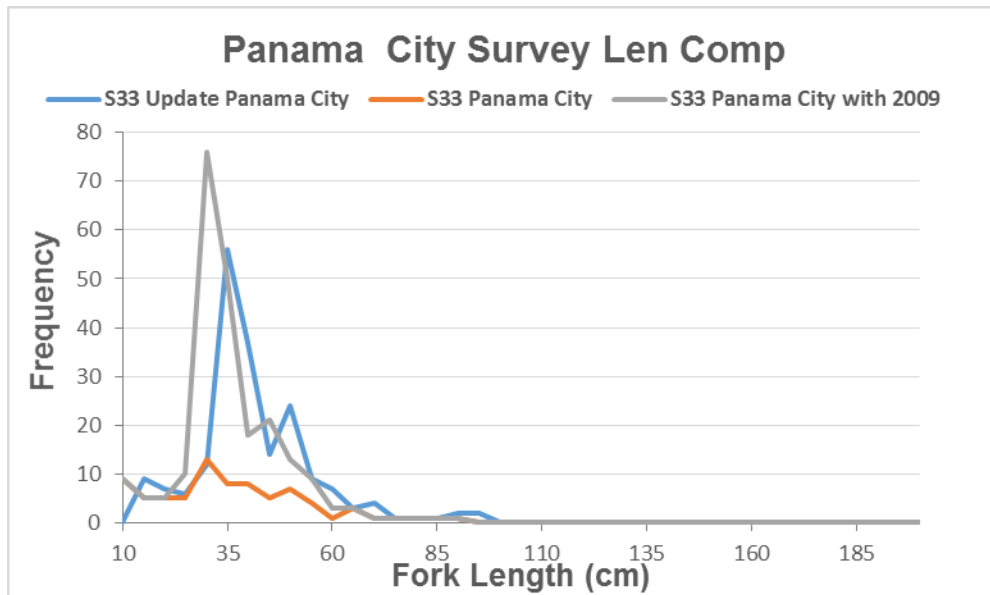


Figure 24. Length composition data of greater amberjack from the Panama City Video Survey for the SEDAR 33 update and SEDAR 33 benchmark assessments. The figures do not include data from 2013-2015.

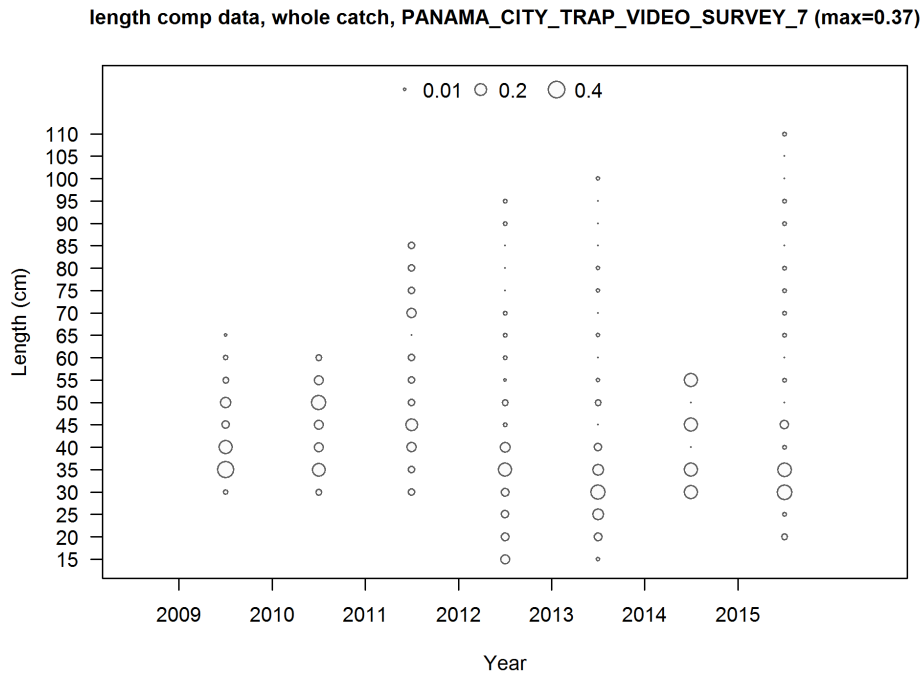
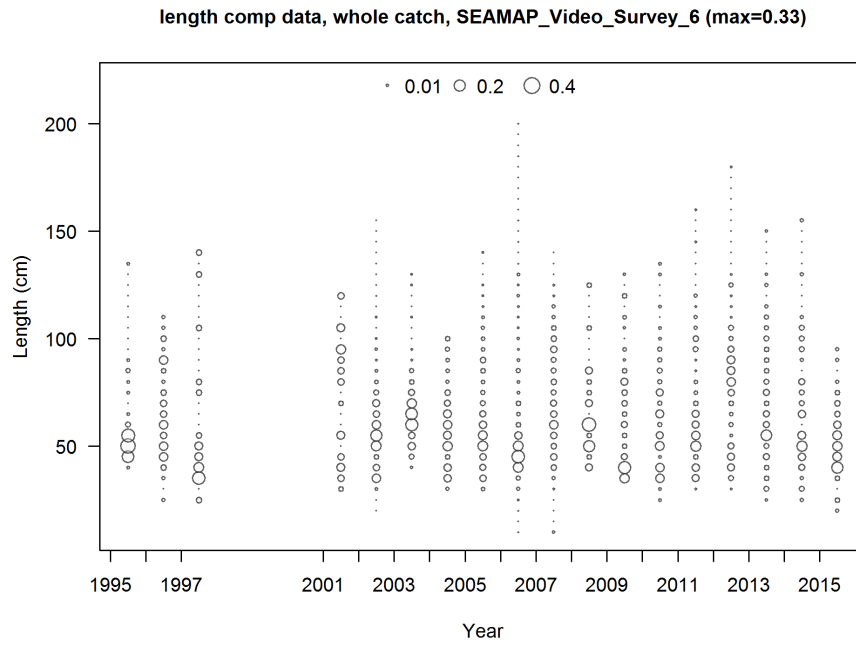


Figure 25. Annual length composition for the a) SEAMAP and Panama City Video Surveys for the SEDAR 33 update assessment for greater amberjack.

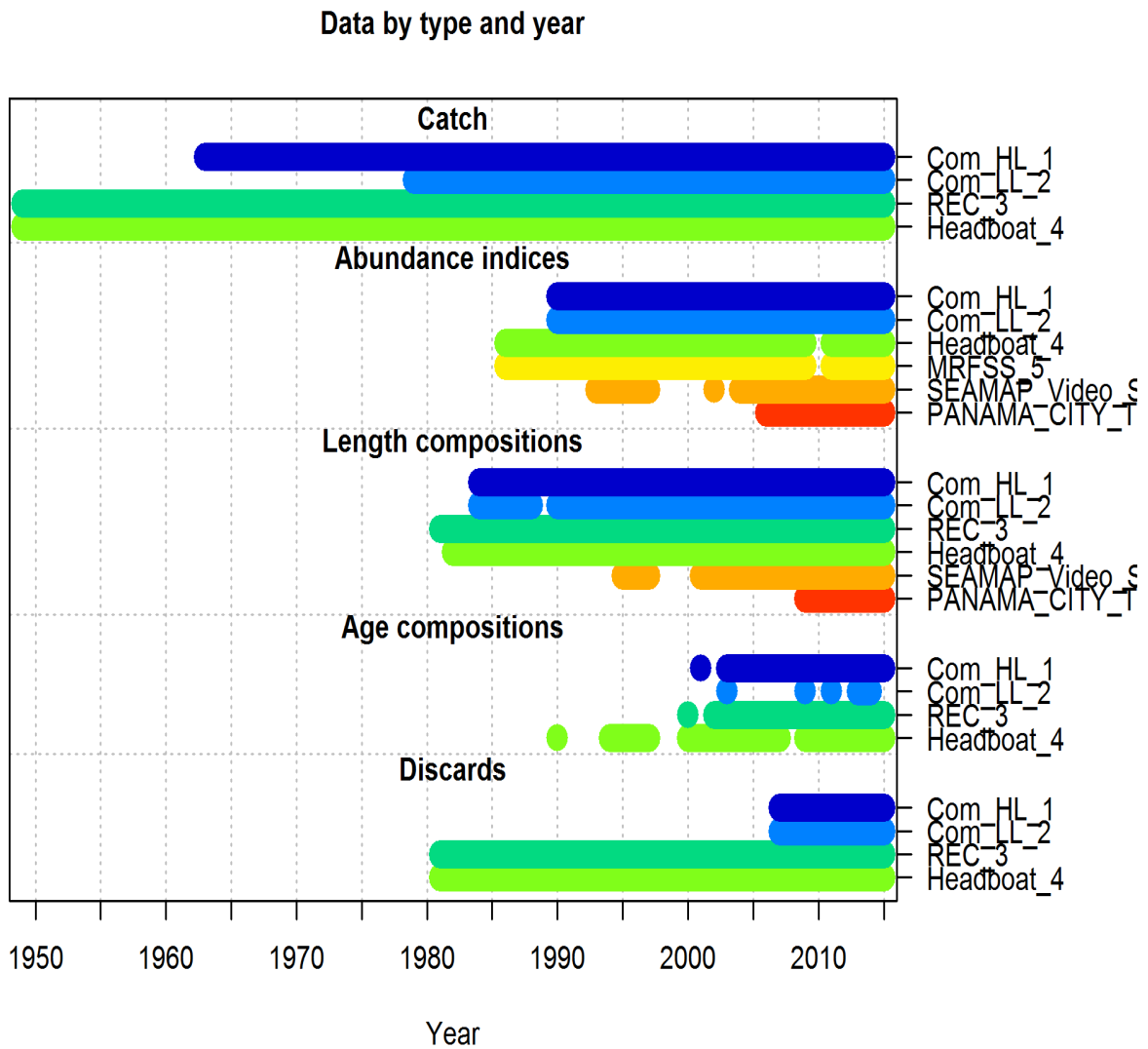


Figure 26. Overview of data inputs available for the SEDAR 33 greater amberjack update assessment.

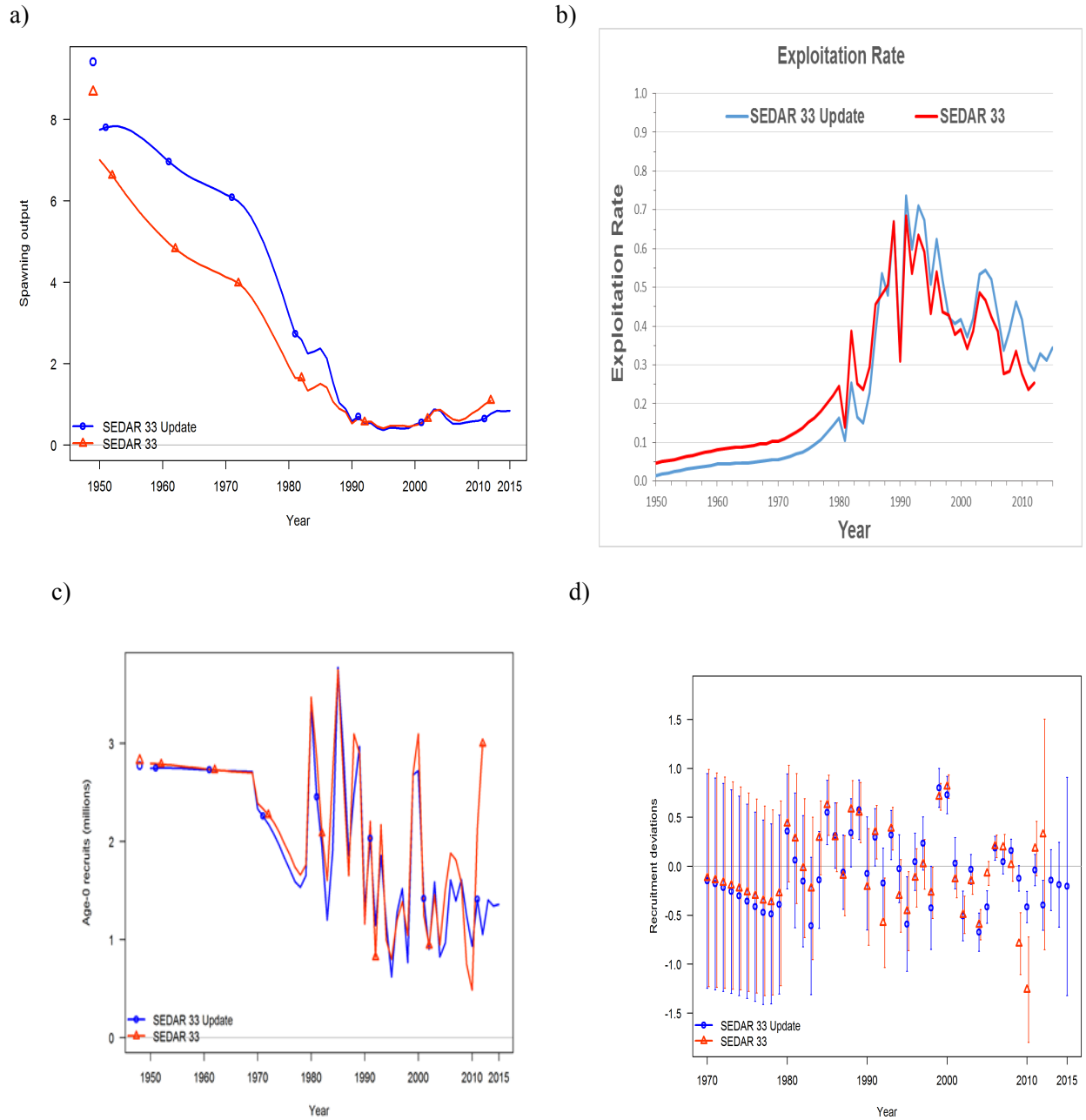
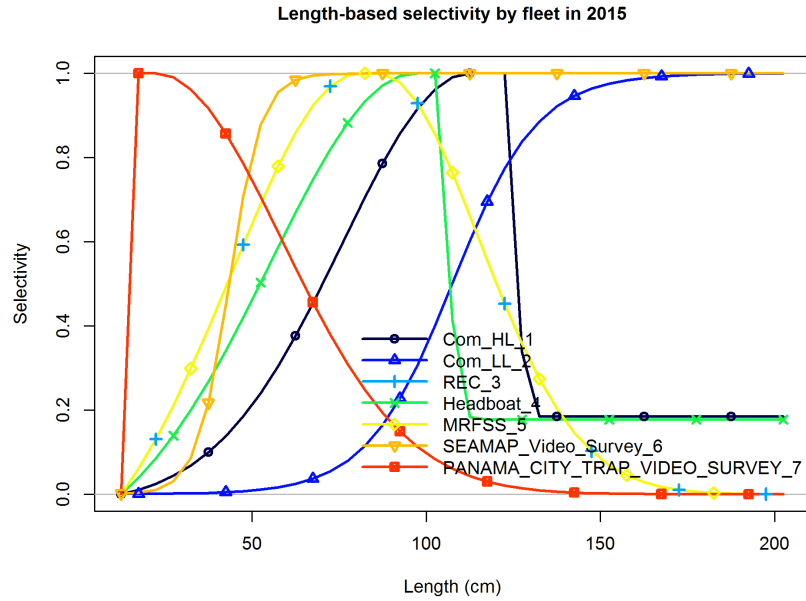


Figure 27. a) Spawning stock biomass (SSB), b) exploitation rate, c) age-0 recruits, and d) recruitment deviations from the SEDAR 33 update model (blue lines) and SEDAR 33 model (red lines) for greater amberjack. Exploitation rate calculated as catch in weight including discards divided by total biomass.



a) SEDAR 33 update model



a) SEDAR 33 benchmark model

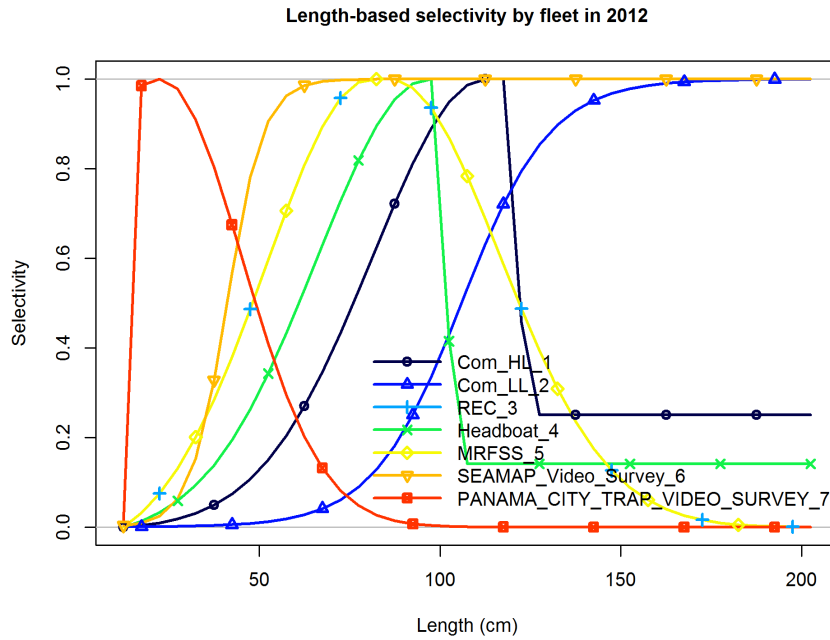
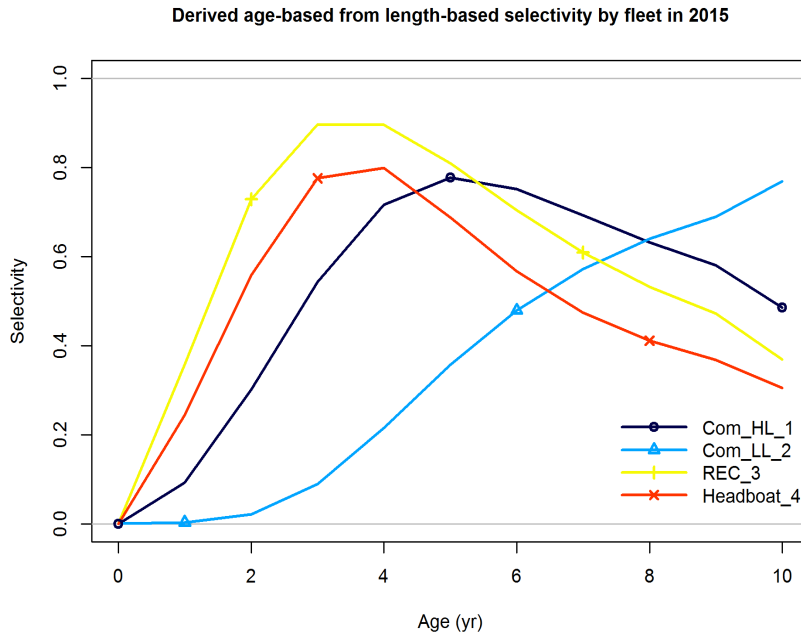


Figure 28. Length selectivity by fleet estimated from the a) SEDAR 33 update and b) SEDAR 33 benchmark models for greater amberjack.

a) SEDAR 33 update model



SEDAR 3 benchmark model

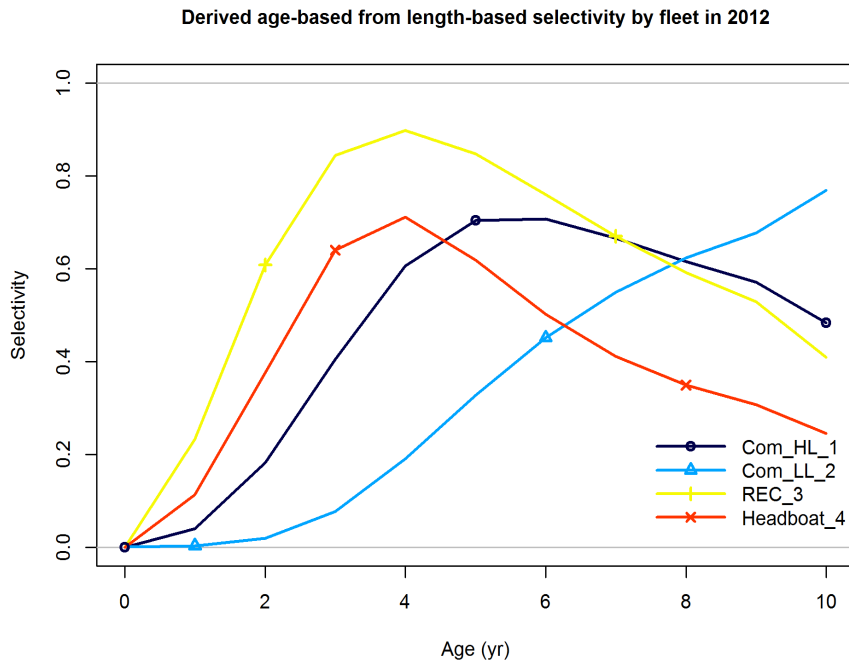


Figure 29. Age selectivity by fleet estimated from the a) SEDAR 33 update model and b) the SEDAR 33 benchmark model for greater amberjack.

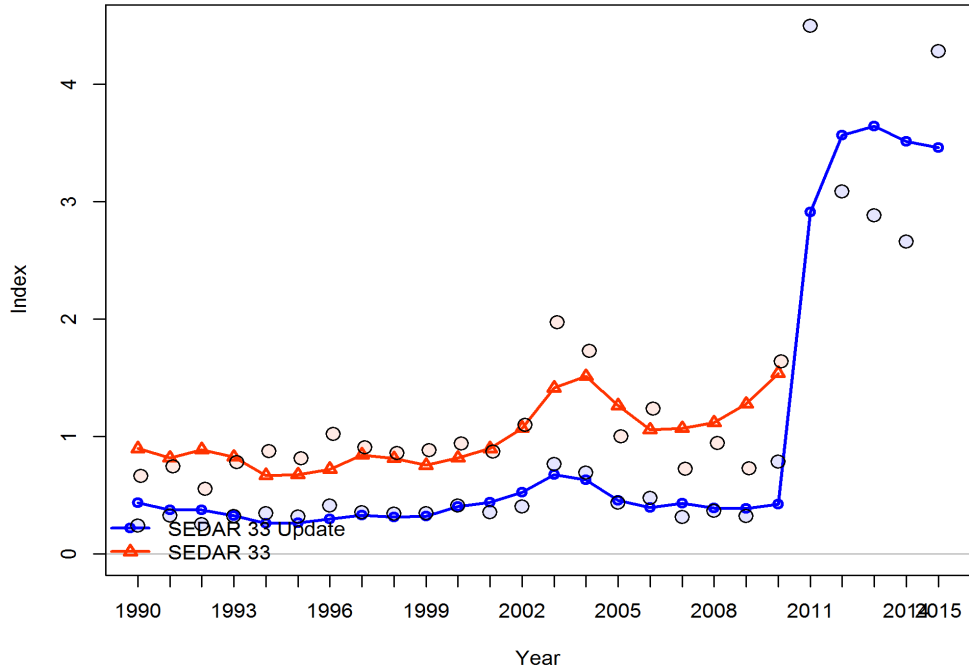


Figure 30. Observed indices of abundance and model fits for the SEDAR 33 update and SEDAR 33 benchmark assessments for the Com\_HL fleet for greater amberjack. Red line and red filled circles = SEDAR 33 benchmark and blue line and blue filled circles = SEDAR 33 update model.

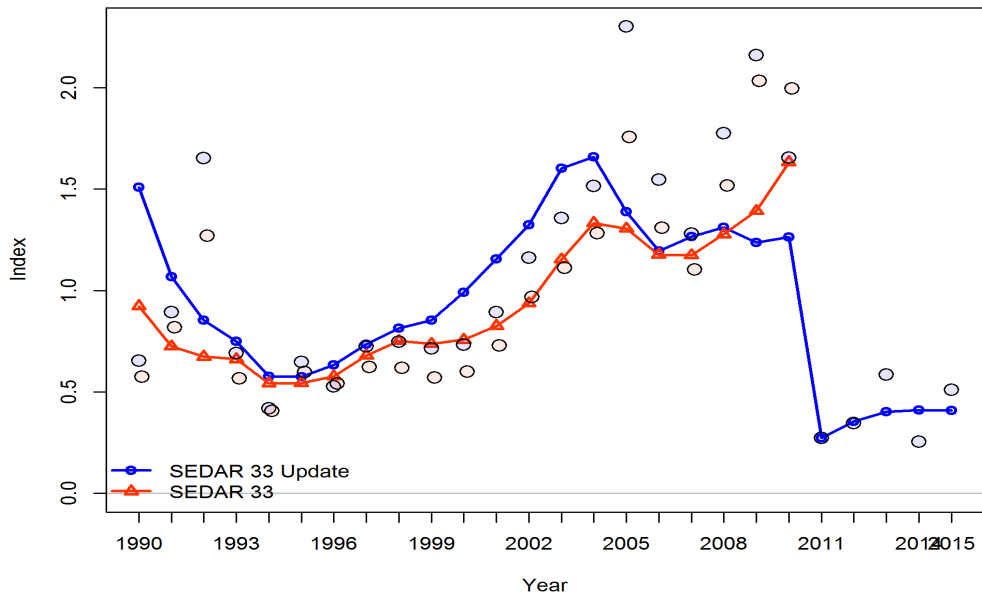


Figure 31. Observed indices of abundance and model fits for the SEDAR 33 update and SEDAR 33 benchmark assessments for the Com\_LL fleet for greater amberjack. Red line and red filled circles = SEDAR 33 benchmark and blue line and blue filled circles = SEDAR 33 update model.

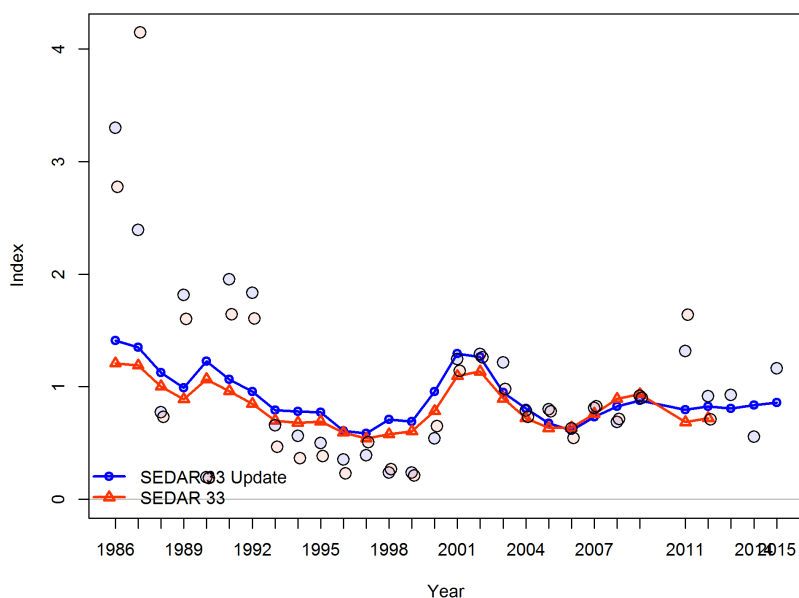


Figure 32. Observed indices of abundance and model fits for the SEDAR 33 update and SEDAR 33 benchmark assessments for the REC survey for greater amberjack. Red line and red filled circles = SEDAR 33 benchmark model and indices and blue line and blue filled circles = SEDAR 33 update model and indices.

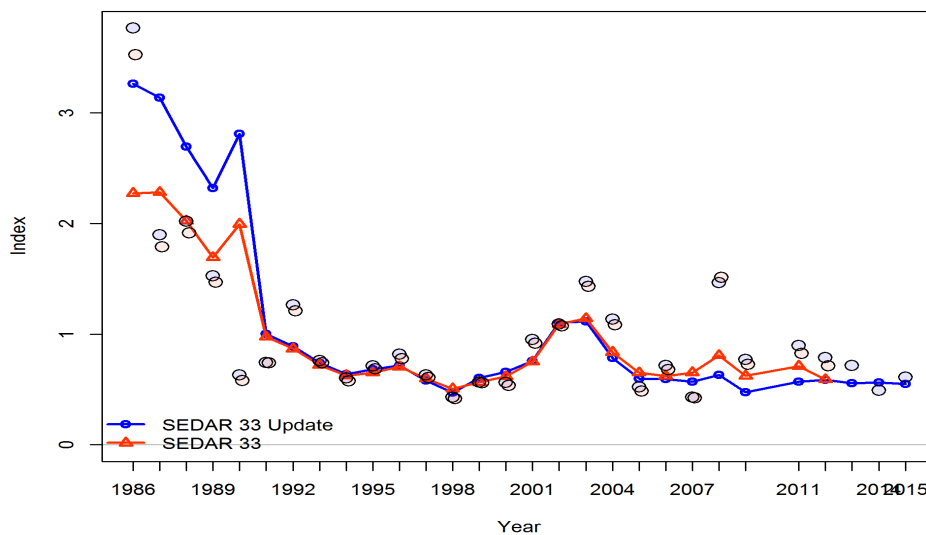


Figure 33. Observed indices of abundance and model fits for the a) SEDAR 33 and b) SEDAR 33 benchmark assessment for the Headboat fleet for greater amberjack. Red line and red filled circles = SEDAR 33 benchmark and blue line and blue filled circles = SEDAR 33 update model.

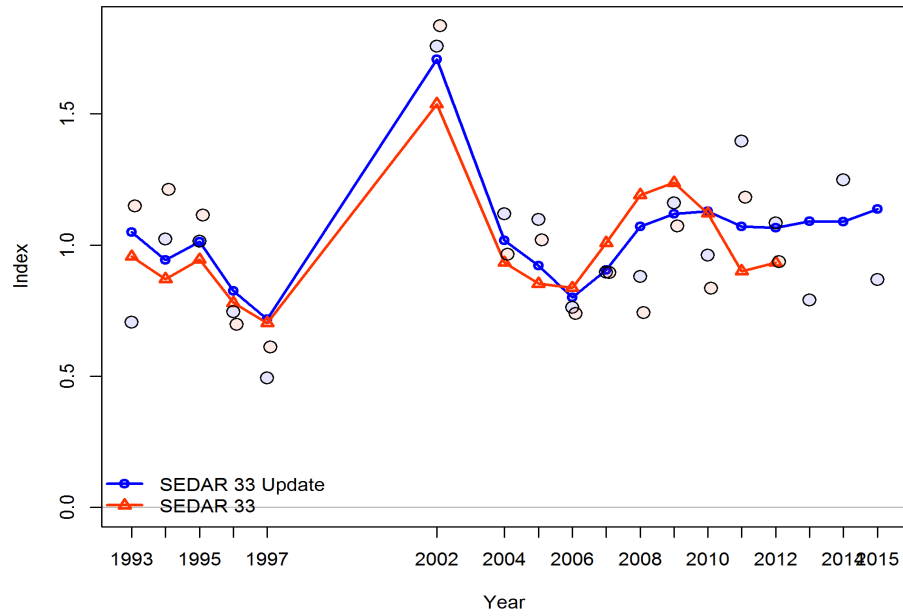


Figure 34. Observed indices of abundance and model fits for the SEDAR update and SEDAR 33 benchmark assessment for the SEDAMAP survey for greater amberjack. . Red line and red filled circles = SEDAR 33 benchmark and blue line and blue filled circles = SEDAR 33 update model.

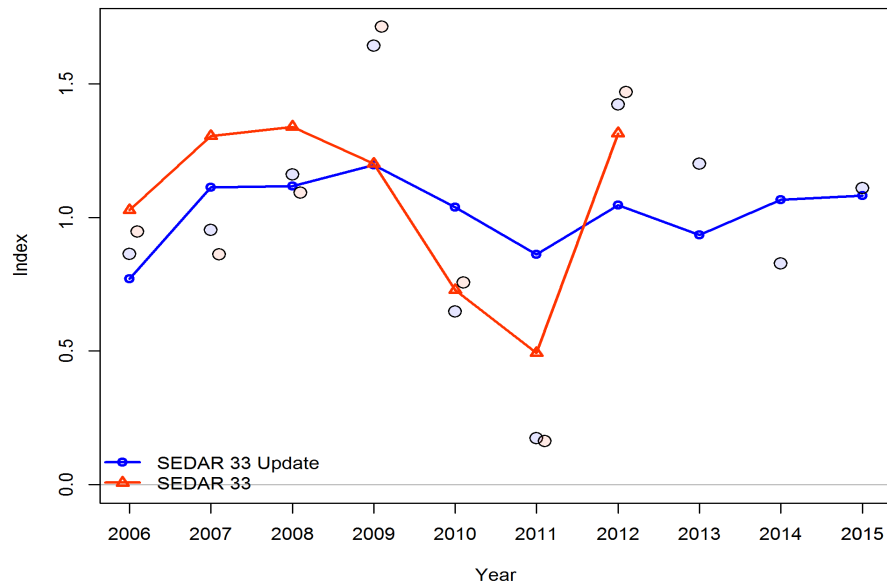


Figure 35. Observed indices of abundance and model fits for the SEDAR 33 update and SEDAR 33 benchmark assessment for the Panama City Video Survey for greater amberjack. . Red line and red filled circles = SEDAR 33 benchmark and blue line and blue filled circles = SEDAR 33 update model.

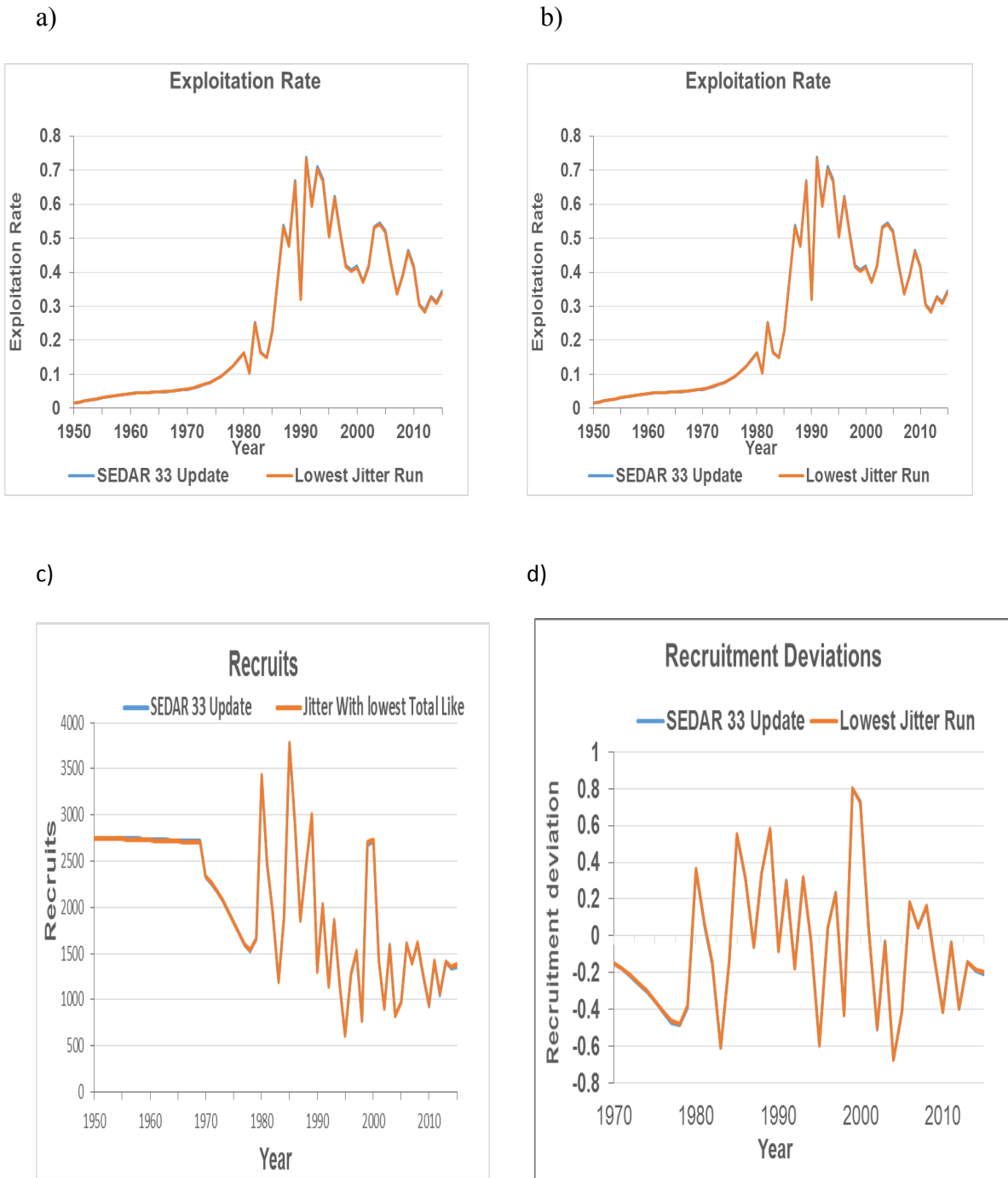


Figure 36. Comparison of the SEDAR 33 Update model (blue line, model 1) and the jitter run with the lowest log likelihood (orange line, model 2); a) SSB, b) exploitation, c) recruitment, and d) recruitment deviations for greater amberjack.

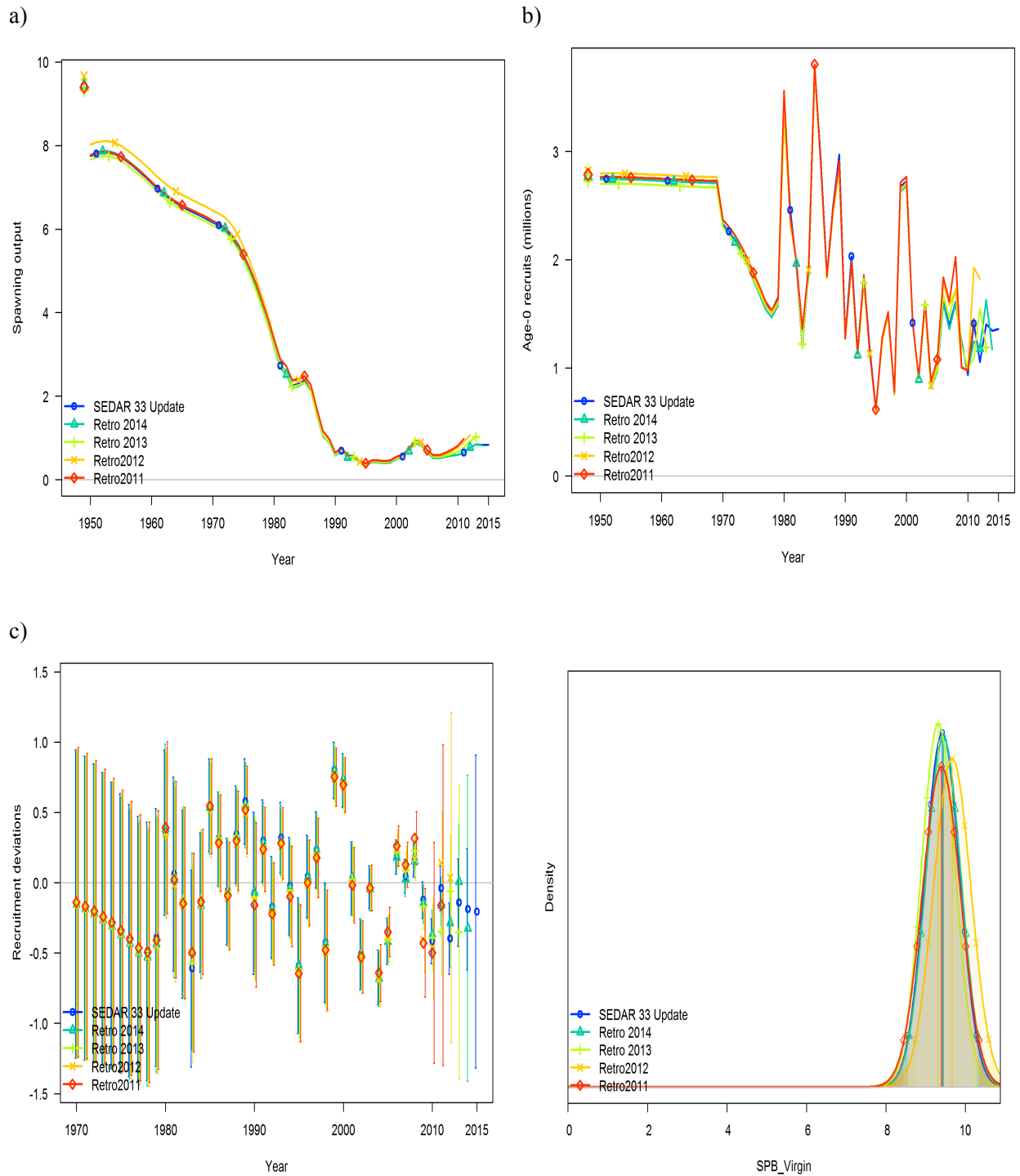
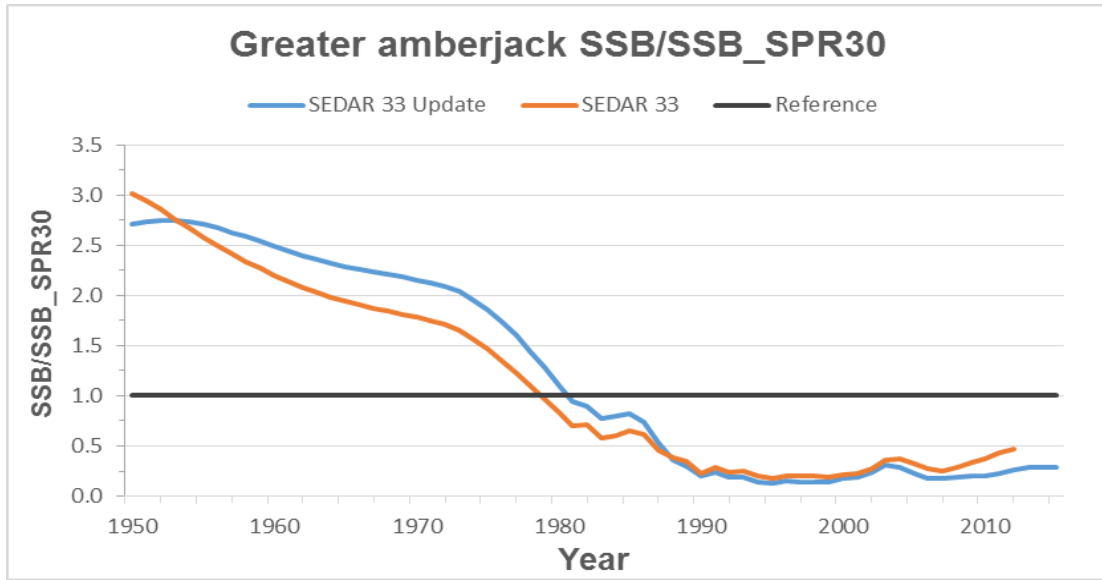


Figure 37 Estimates of a) spawning stock biomass (SSB), b) age-0 recruits, c) recruitment deviations, and d) density of virgin spawning biomass from the retrospective analysis of the SEDAR 33 Update model for greater amberjack. Model 1 represents the full model through 2015. Each successive model represents the sequential removal of a single year (2014-2011). Symbols in 1950 represent estimates of SBB under unfished conditions.

a)



b)

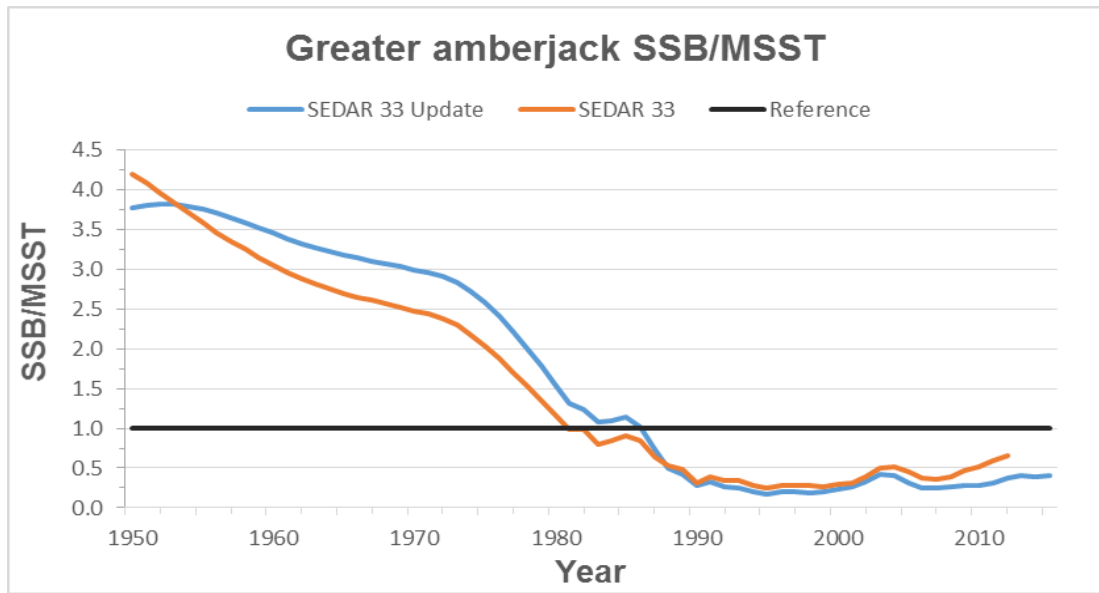


Figure 38. Estimated annual trajectory of a) SSB/SSB\_SPR30%, b) SSB/MSST and c) F/FMFMT for the SEDAR 33 update model and the SEDAR 33 assessment model for greater amberjack.



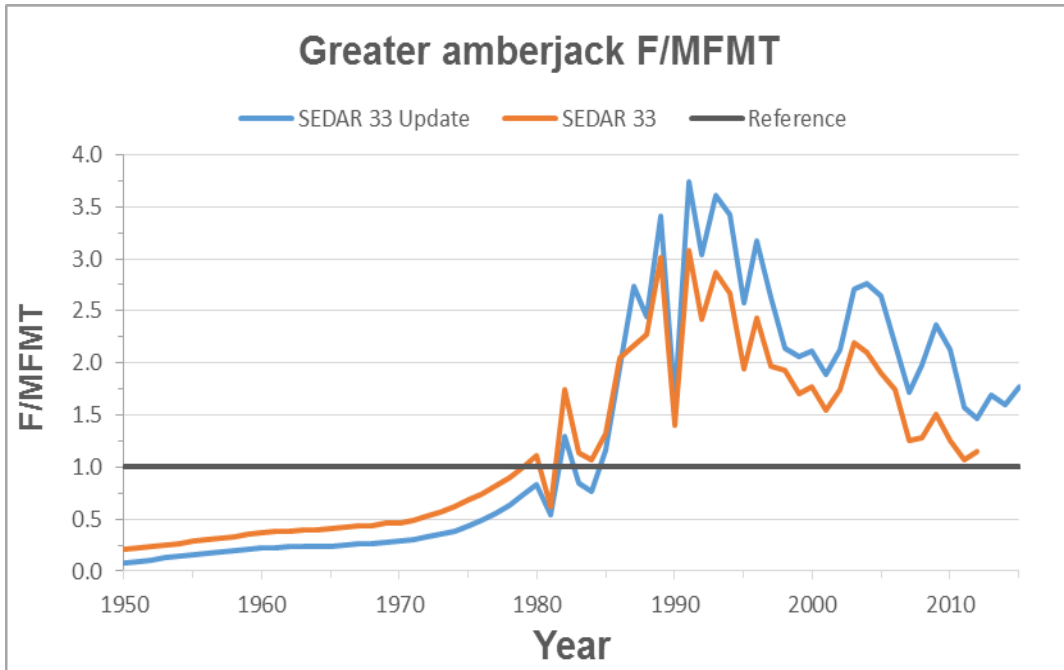
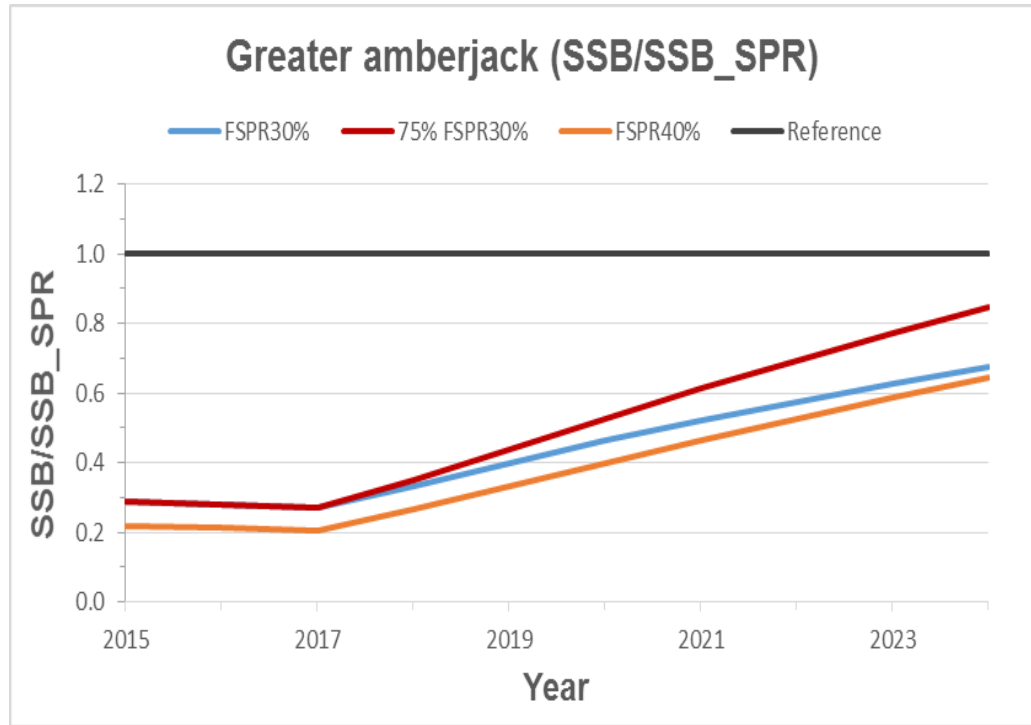


Figure 38c. Estimated annual trajectory of SSB/SSB\_SPR30%, SSB/MSST, and F/MFMT for the SEDAR 33 update model and the SEDAR 33 assessment model for greater amberjack.

a)



b)

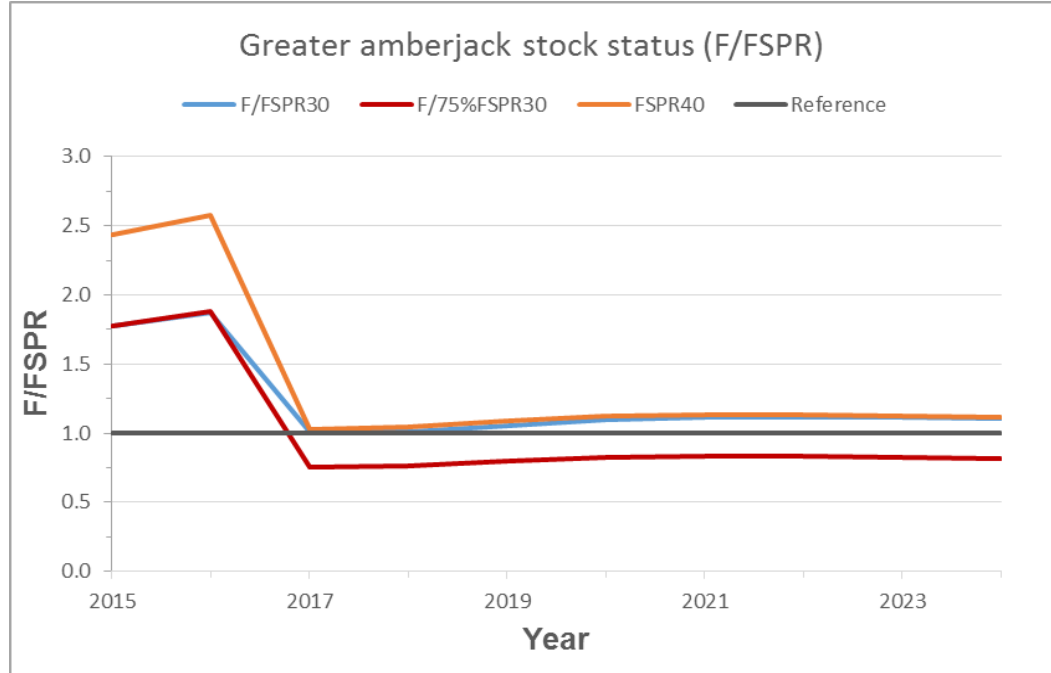


Figure 39. Projections for the SEDAR 33 update model for Gulf of Mexico greater amberjack: a) SSB/FSPR30, SSB/75%FSPR30, and SSB/FSPR40, b) F/FSPR30, F/75%FSPR30, and F/FSPR40.

Table 1. Commercial landings and quotas for Gulf of Mexico greater amberjack (MTons whole weight).

<b>YEAR</b>	<b>Com_HL</b>	<b>Com_LL</b>	<b>Combined</b>
1963	3.82	0.00	3.82
1964	2.86	0.00	2.86
1965	2.35	0.00	2.35
1966	3.32	0.00	3.32
1967	13.11	0.00	13.11
1968	5.17	0.00	5.17
1969	32.73	0.00	32.73
1970	6.13	0.00	6.13
1971	17.27	0.00	17.27
1972	18.70	0.00	18.70
1973	12.69	0.00	12.69
1974	18.74	0.00	18.74
1975	35.08	0.00	35.08
1976	38.82	0.00	38.82
1977	53.82	0.00	53.82
1978	67.65	0.00	67.65
1979	66.77	1.24	68.01
1980	77.91	2.19	80.10
1981	95.45	10.12	105.57
1982	82.89	17.66	100.55
1983	104.76	20.47	125.23
1984	209.82	27.70	237.52
1985	293.59	51.88	345.48
1986	417.24	95.09	512.32
1987	588.82	119.42	708.23
1988	785.24	157.03	942.27
1989	748.28	144.74	893.01
1990	513.23	60.42	573.64
1991	805.44	3.29	808.73
1992	456.92	25.15	482.06
1993	695.60	41.01	736.61
1994	550.02	33.94	583.96
1995	525.76	38.17	563.93
1996	538.54	26.81	565.36
1997	459.23	25.87	485.10
1998	274.99	23.37	298.36
1999	302.97	28.25	331.22
2000	354.97	30.90	385.87
2001	299.64	20.97	320.61
2002	313.24	35.62	348.86
2003	382.41	53.29	435.70
2004	394.66	36.73	431.38
2005	292.82	32.60	325.42

2006	234.13	34.38	268.51
2007	239.81	26.85	266.66
2008	171.58	41.10	212.68
2009	247.44	22.40	269.84
2010	241.54	10.31	251.85
2011	230.63	5.04	235.67
2012	138.54	4.49	143.03
2013	206.00	7.45	213.45
2014	224.44	9.59	234.03
2015	211.80	13.24	225.04

Table2a. Recreational landings in numbers (1,000s) and the percent (%) difference between the SEDAR 33 update and SEDAR 33 benchmark assessment estimates for the charter and private angler fisheries (REC fleet) for greater amberjack. Note: 2013-2015 values not compared.

Year	1000's of fish (REC fleet)		
	SEDAR 33 Update Charter + Private	SEDAR 33 Charter + Private	% Difference (S33 Update - S33) Charter + Private
1981	134.32	127.53	5.06
1982	396.66	496.54	-25.18
1983	202.33	252.13	-24.61
1984	136.64	190.80	-39.64
1985	184.82	238.29	-28.93
1986	375.76	379.17	-0.91
1987	553.26	360.40	34.86
1988	260.84	265.11	-1.64
1989	399.07	381.72	4.35
1990	50.20	48.17	4.06
1991	241.16	239.51	0.68
1992	138.42	137.11	0.94
1993	130.24	130.03	0.16
1994	96.76	94.53	2.30
1995	41.46	39.06	5.78
1996	84.20	80.85	3.97
1997	45.44	43.95	3.30
1998	45.09	61.18	-35.69
1999	48.87	46.89	4.06
2000	57.23	55.58	2.90
2001	78.62	74.61	5.11
2002	127.93	123.24	3.67
2003	171.44	163.12	4.86
2004	131.28	118.96	9.38
2005	104.54	90.59	13.34
2006	66.62	75.74	-13.68
2007	43.09	45.37	-5.29
2008	76.40	70.11	8.23
2009	77.99	69.06	11.45
2010	72.71	59.16	18.64
2011	48.97	47.62	2.76
2012	57.76	57.16	1.05
2013	64.89		
2014	59.23		
2015	69.44		

Table2b. Recreational headboat landings in numbers (1,000s) and the percent difference between the SEDAR 33 update and the SEDAR 33 benchmark assessment estimates. 2013-2015 values not compared.

<b>Headboat Landings (1000's of fish)</b>			
<b>Year</b>	<b>S33 Update</b>	<b>S33</b>	<b>% difference (S33 Update - S33)</b>
1986	86.02	86.02	0.00
1987	52.89	52.89	0.00
1988	29.66	29.66	0.00
1989	52.52	52.52	0.00
1990	24.26	24.26	0.00
1991	9.85	9.85	0.00
1992	19.75	19.75	0.00
1993	14.05	14.05	0.00
1994	13.12	13.12	0.00
1995	8.67	8.67	0.00
1996	10.51	10.51	0.00
1997	7.54	7.54	0.00
1998	5.11	5.11	0.00
1999	5.29	5.29	0.00
2000	6.00	6.00	0.00
2001	6.01	6.01	0.00
2002	10.69	10.69	0.00
2003	11.98	11.98	0.00
2004	6.24	6.24	0.00
2005	3.99	3.99	0.00
2006	4.73	4.73	0.00
2007	4.46	4.46	0.00
2008	4.82	4.82	0.00
2009	5.24	5.24	0.00
2010	2.57	2.57	0.00
2011	2.99	2.99	0.00
2012	3.84	3.84	0.00
2013	3.13	-	-
2014	1.99	-	-
2015	2.87	-	-

Table 1a. Historical recreational REC fleet landings in numbers (1,000s) and the percent difference between the SEDAR 33 update and SEDAR 33 benchmark estimates for greater amberjack.

Year	1000's of fish		
	SEDAR 33 Update Charter + Private	SEDAR 33 Charter + Private	% difference (SEDAR 33 Update – SEDAR 33 benchmark) Charter + Private
1950	45	89	-99.13
1951	54	94	-75.67
1952	62	99	-58.92
1953	71	104	-46.35
1954	80	110	-36.58
1955	89	115	-28.76
1956	95	120	-26.57
1957	101	125	-24.63
1958	106	131	-22.90
1959	112	136	-21.34
1960	118	141	-19.93
1961	118	142	-20.56
1962	118	143	-21.18
1963	118	144	-21.81
1964	119	145	-22.43
1965	119	147	-23.05
1966	122	149	-22.35
1967	125	152	-21.69
1968	128	155	-21.05
1969	131	157	-20.44
1970	133	160	-19.86
1971	138	167	-20.85
1972	143	174	-21.77
1973	147	181	-22.64
1974	152	188	-23.45
1975	157	195	-24.21
1976	166	197	-18.70
1977	175	199	-13.75
1978	184	201	-9.28
1979	193	203	-5.23
1980	201	205	-1.54

Table 2b. Historical recreational Headboat landings in numbers (1,000s of fish) and the percent difference between the SEDAR 33 update and SEDAR 33 benchmark estimates for greater amberjack. Differences in SEDAR 33 update and SEDAR 33 landings are due to application of SEDAR Best Practices (SEDAR 2015) recommendations after the SEDAR 33 benchmark assessment.

<b>Year</b>	<b>SEDAR 33 Update (1,000's)</b>	<b>SEDAR 33 (1,000's)</b>	<b>SEDAR 33 % Difference (SEDAR 33 Update – SEDAR 33)</b>
1950	0.512	34.500	(6,644.11)
1951	0.614	34.500	(5,520.09)
1952	0.716	34.500	(4,717.22)
1953	0.818	34.500	(4,115.07)
1954	0.921	34.500	(3,646.73)
1955	1.023	34.500	(3,272.05)
1956	1.364	34.500	(2,429.04)
1957	1.705	34.500	(1,923.23)
1958	2.046	34.500	(1,586.03)
1959	2.387	34.500	(1,345.17)
1960	2.728	34.500	(1,164.52)
1961	3.069	34.500	(1,024.02)
1962	3.410	34.500	(911.62)
1963	3.751	34.500	(819.65)
1964	4.092	34.500	(743.01)
1965	4.434	34.500	(678.17)
1966	4.843	34.500	(612.41)
1967	5.252	34.500	(556.89)
1968	5.661	34.500	(509.41)
1969	6.070	34.500	(468.32)
1970	6.480	34.500	(432.43)
1971	6.480	34.500	(432.43)
1972	6.821	34.500	(405.81)
1973	7.162	34.500	(381.72)
1974	7.162	34.500	(381.72)
1975	9.890	34.500	(248.83)
1976	9.549	34.500	(261.29)
1977	8.867	34.500	(289.08)
1978	8.526	34.500	(304.65)
1979	9.549	34.500	(261.29)
1980	9.549	34.500	(261.29)
1981	8.526	34.500	(304.65)
1982	8.867	34.500	(289.08)
1983	7.844	34.500	(339.83)
1984	8.526	34.500	(304.65)
1985	8.867	34.500	(289.08)



Table 4a. Recreational discard estimates and the percent difference for charter and private angler fisheries (REC fleet) between the SEDAR 33 update and SEDAR 33 benchmark assessments for greater amberjack. 2013-2015 estimates not compared.

<b>Year</b>	<b>SEDAR 33 Update Charter + Private</b>	<b>SEDAR 33 Charter + Private</b>	<b>% difference (S33 Update - S33) Charter + Private</b>
1981	25.13	17.89	28.82
1982	93.02	66.07	28.98
1983	156.18	95.76	38.69
1984	36.63	26.65	27.25
1985	10.51	8.51	19.06
1986	66.14	55.71	15.78
1987	68.32	33.12	51.52
1988	118.96	77.30	35.02
1989	206.36	124.60	39.62
1990	124.94	79.40	36.45
1991	261.10	247.25	5.31
1992	217.63	161.49	25.80
1993	205.57	157.52	23.37
1994	153.06	110.95	27.52
1995	110.97	66.74	39.86
1996	80.95	63.59	21.45
1997	69.21	48.63	29.74
1998	158.72	105.09	33.79
1999	137.17	95.34	30.49
2000	218.60	134.38	38.53
2001	925.37	548.75	40.70
2002	498.95	316.30	36.61
2003	422.08	261.79	37.98
2004	313.61	175.11	44.16
2005	323.37	211.55	34.58
2006	138.54	180.32	-30.16
2007	608.38	188.08	69.08
2008	210.93	178.14	15.55
2009	177.02	137.73	22.20
2010	430.21	305.11	29.08
2011	352.25	179.10	49.16
2012	144.99	112.23	22.59
2013	326.48		
2014	210.35		
2015	293.84		

Table 4b. Discard estimates for the headboat fleet for the SEDAR 33 update and SEDAR 33 benchmark assessments for greater amberjack.

<b>Year</b>	<b>SEDAR 33 Update (1,000's)</b>	<b>SEDAR 33 (1,000's)</b>	<b>% Difference S33 Update and S33</b>
1981	0.840	0.840	0.00
1982	5.159	5.159	0.00
1983	3.581	3.581	0.00
1984	0.488	0.488	0.00
1985	0.503	0.503	0.00
1986	15.143	1.371	90.95
1987	6.531	0.640	90.20
1988	13.527	0.381	97.18
1989	27.159	3.053	88.76
1990	60.375	25.655	57.51
1991	10.667	9.407	11.81
1992	31.047	7.268	76.59
1993	22.181	14.056	36.63
1994	20.748	0.283	98.64
1995	23.206	9.022	61.12
1996	10.106	9.706	3.96
1997	11.480	5.429	52.71
1998	17.988	12.856	28.53
1999	14.836	8.948	39.69
2000	22.917	5.212	77.26
2001	70.725	12.149	82.82
2002	41.690	11.800	71.70
2003	29.484	10.249	65.24
2004	14.912	2.929	80.36
2005	12.351	3.911	68.33
2006	9.828	2.748	72.04
2007	62.994	5.215	91.72
2008	13.316	10.505	21.11
2009	11.891	9.232	22.36
2010	15.212	4.043	73.42
2011	21.522	4.230	80.35
2012	9.629	4.059	57.85
2013	15.750	-	-
2014	7.080	-	-
2015	12.130	-	-

Table 5. Jitter analysis results from the SEDAR 33 update continuity model for greater amberjack. Columns refer to individual data components in the Stock Synthesis SS3 model.

Run	Likelihood Component						
	TOTAL	Catch	Survey	Discard	Length_comp	Age_comp	Recruitment
42	1186.58	8.88E-05	-51.08	305.90	605.52	334.20	-7.99
123	1186.72	8.86E-05	-51.28	305.91	605.93	334.12	-7.99
179	1188.68	8.94E-05	-50.50	307.11	605.57	334.50	-8.04
134	1189.89	6.82E-05	-51.44	305.54	609.08	334.44	-7.77
40	1191.02	9.78E-05	-51.83	306.23	607.31	337.24	-7.95
51	1191.02	9.78E-05	-51.83	306.23	607.31	337.24	-7.95
77	1191.02	9.78E-05	-51.83	306.23	607.31	337.24	-7.95
119	1191.02	9.78E-05	-51.83	306.23	607.31	337.24	-7.95
145	1191.02	9.78E-05	-51.83	306.23	607.31	337.24	-7.95
163	1191.02	9.78E-05	-51.83	306.23	607.31	337.24	-7.95
165	1191.02	9.78E-05	-51.83	306.23	607.31	337.24	-7.95
178	1191.02	9.78E-05	-51.83	306.23	607.31	337.24	-7.95
174	1191.03	9.8E-05	-51.85	306.23	607.40	337.17	-7.95
9	1191.1	9.82E-05	-51.71	306.22	607.26	337.24	-7.95
60	1191.12	9.78E-05	-51.76	306.22	607.34	337.22	-7.95
54	1191.9	9.82E-05	-51.87	306.05	608.33	337.28	-7.92
192	1192.28	9.75E-05	-51.57	306.21	608.36	337.20	-7.95
10	1193.06	9.85E-05	-51.07	307.48	606.98	337.63	-7.99
14	1193.06	9.85E-05	-51.07	307.48	606.98	337.63	-7.99
16	1193.06	9.85E-05	-51.07	307.48	606.98	337.63	-7.99
29	1193.06	9.85E-05	-51.07	307.48	606.98	337.63	-7.99
76	1193.06	9.85E-05	-51.07	307.48	606.98	337.63	-7.99
95	1193.06	9.85E-05	-51.07	307.48	606.98	337.63	-7.99
146	1193.06	9.85E-05	-51.07	307.48	606.98	337.63	-7.99
191	1193.06	9.85E-05	-51.07	307.48	606.98	337.63	-7.99
100	1193.25	9.86E-05	-51.27	307.50	607.40	337.60	-8.01
26	1193.28	9.87E-05	-51.15	307.49	607.35	337.55	-7.99
120	1193.28	9.87E-05	-51.15	307.49	607.35	337.55	-7.99
107	1193.9	7.61E-05	-52.04	305.88	610.64	337.30	-7.92
140	1193.9	7.61E-05	-52.04	305.88	610.64	337.30	-7.92
66	1194.1	7.64E-05	-51.83	305.87	610.65	337.30	-7.92
180	1194.19	7.8E-05	-49.35	306.86	609.48	334.81	-7.63
177	1195.68	9.09E-05	-49.57	310.29	608.09	334.91	-8.07
24	1195.94	7.74E-05	-51.27	307.13	610.31	337.69	-7.95
46	1195.94	7.74E-05	-51.27	307.13	610.31	337.69	-7.95
64	1195.94	7.74E-05	-51.27	307.13	610.31	337.69	-7.95
142	1195.94	7.74E-05	-51.27	307.13	610.31	337.69	-7.95
93	1197.76	7.91E-05	-50.74	305.80	613.35	337.21	-7.90

38	1197.87	7.94E-05	-50.72	305.80	613.44	337.21	-7.90
73	1199.07	7.42E-05	-50.10	308.78	609.45	338.80	-7.89
57	1200.43	9.87E-05	-48.91	309.95	609.27	338.19	-8.10
55	1200.55	9.38E-05	-50.51	315.24	606.27	337.61	-8.09
67	1200.91	9.53E-05	-48.62	308.80	609.12	338.69	-7.11
50	1203.22	7.85E-05	-48.73	308.68	612.66	338.79	-8.20
84	1205.24	8.17E-05	-48.21	315.32	608.45	338.80	-9.15
122	1205.79	6.6E-05	-48.99	307.98	616.73	337.61	-7.57
53	1206.97	6.53E-05	-47.20	314.58	610.03	338.48	-8.95
162	1207.28	7.07E-05	-49.15	315.40	610.03	338.90	-7.93
183	1210.45	7.5E-05	-48.25	315.35	612.22	338.86	-7.77
80	1214.43	4.72E-05	-47.59	314.54	615.76	339.11	-7.40
28	1230.99	0.005746	-40.98	310.56	613.19	355.44	-7.25
161	1231.01	0.005584	-40.99	310.55	613.41	355.22	-7.23
44	1231.06	0.006299	-41.61	309.11	613.57	356.88	-6.93
116	1231.29	0.006026	-41.69	309.09	614.62	356.18	-6.95
48	1231.81	0.000883	-41.96	308.78	615.72	356.13	-6.90
25	1232.28	0.005785	-40.76	310.66	612.56	356.99	-7.20
169	1233.18	0.009724	-42.12	309.22	614.50	358.47	-6.92
7	1233.19	0.009733	-42.12	309.22	614.44	358.51	-6.92
124	1233.19	0.009733	-42.12	309.22	614.44	358.51	-6.92
4	1233.22	0.013469	-42.46	309.44	613.68	359.36	-6.85
199	1233.22	0.013469	-42.46	309.44	613.68	359.36	-6.85
41	1234.43	0.009599	-41.35	310.84	613.40	358.71	-7.21
74	1234.43	0.009599	-41.35	310.84	613.40	358.71	-7.21
89	1234.43	0.009599	-41.35	310.84	613.40	358.71	-7.21
94	1234.43	0.009599	-41.35	310.84	613.40	358.71	-7.21
184	1234.43	0.009599	-41.35	310.84	613.40	358.71	-7.21
186	1234.45	0.009658	-41.32	310.83	613.45	358.66	-7.21
56	1234.53	0.019638	-41.64	311.06	612.67	359.54	-7.14
35	1235.06	0.001796	-42.33	309.02	615.89	359.35	-6.89
126	1235.06	0.001796	-42.33	309.02	615.89	359.35	-6.89
190	1235.06	0.001796	-42.33	309.02	615.89	359.35	-6.89
197	1235.09	0.001815	-42.30	309.02	615.93	359.29	-6.89
79	1235.64	0.009994	-41.18	310.91	612.87	360.19	-7.19
130	1235.77	0.001746	-42.34	309.02	616.57	359.37	-6.90
70	1236.21	0.001892	-42.23	309.13	615.44	360.73	-6.90
63	1236.35	0.00159	-41.52	310.63	614.85	359.53	-7.18
87	1236.35	0.00159	-41.52	310.63	614.85	359.53	-7.18
151	1236.35	0.00159	-41.52	310.63	614.85	359.53	-7.18
172	1236.35	0.00159	-41.52	310.63	614.85	359.53	-7.18
167	1236.5	0.009939	-41.49	309.30	615.88	359.70	-6.93
18	1237.13	0.022475	-41.12	311.13	613.06	361.10	-7.11

39	1238.39	0.001858	-41.67	309.10	617.33	360.50	-6.91
113	1238.4	0.006879	-39.26	309.34	614.96	360.33	-7.01
101	1238.77	0.027129	-40.67	311.22	613.94	361.49	-7.26
103	1238.93	0.0121	-40.16	310.95	614.68	360.58	-7.16
69	1239.35	0.002425	-41.28	309.17	617.20	361.12	-6.89
154	1239.74	0.006335	-38.34	310.85	613.95	360.48	-7.23
189	1240.31	0.001094	-39.47	309.14	616.54	361.05	-6.98
47	1240.78	0.002246	-40.37	310.74	616.18	361.33	-7.13
99	1240.79	0.002272	-40.36	310.75	616.17	361.33	-7.13
108	1240.85	0.010345	-39.97	309.55	614.68	363.57	-7.03
20	1241.06	0.000731	-38.64	310.64	614.70	361.54	-7.22
157	1241.54	0.011283	-39.73	309.54	615.47	363.22	-7.01
158	1241.55	0.011207	-39.73	309.54	615.47	363.23	-7.01
88	1241.63	0.000628	-40.67	310.08	617.27	361.23	-6.31
115	1241.69	0.007223	-39.08	310.30	615.07	362.70	-7.34
106	1242.24	0.010317	-39.06	311.08	613.64	363.79	-7.24
90	1242.38	0.010379	-38.95	311.08	613.73	363.72	-7.24
3	1242.46	0.005417	-39.10	310.12	616.19	362.55	-7.34
112	1242.75	0.014905	-39.44	310.40	615.44	363.57	-7.26
132	1242.95	0.011222	-38.83	311.08	614.44	363.45	-7.23
127	1243.01	0.010988	-38.91	311.13	614.57	363.33	-7.15
171	1243.03	0.028359	-39.15	311.29	613.68	364.29	-7.15
188	1243.03	0.028359	-39.15	311.29	613.68	364.29	-7.15
166	1243.31	0.005864	-38.90	310.12	617.02	362.36	-7.33
92	1243.68	0.004135	-40.07	309.33	616.69	363.96	-6.28
5	1244.77	0.00192	-39.04	310.88	615.99	364.11	-7.19
72	1244.77	0.00192	-39.04	310.88	615.99	364.11	-7.19
19	1293.6	0.00783	-41.68	319.33	661.40	361.82	-7.32
34	1295.94	0.000159	-42.70	328.39	657.96	359.87	-7.61
150	1298.18	0.0066	-41.46	327.07	658.15	361.84	-7.47
58	1298.75	0.006072	-40.82	328.63	656.30	362.31	-7.71
86	1299.71	0.03748	-40.20	328.46	657.53	361.56	-7.70
81	1299.87	0.015121	-41.38	326.71	659.82	362.14	-7.48
128	1300.08	0.015384	-41.32	326.70	660.08	362.04	-7.47
175	1302.15	0.009222	-40.64	327.59	662.05	360.93	-7.82
196	1302.69	0.00808	-56.36	314.42	680.80	370.48	-6.70
176	1304.66	0.000255	-56.51	314.42	683.14	370.12	-6.56
62	1307.12	0.009547	-55.44	318.23	680.10	370.92	-6.75
31	1308.6	0.020526	-57.00	314.95	682.59	374.60	-6.60
133	1308.6	0.020526	-57.00	314.95	682.59	374.60	-6.60
17	1308.63	0.021253	-56.88	314.95	682.51	374.61	-6.61
143	1308.63	0.021253	-56.88	314.95	682.51	374.61	-6.61
195	1308.71	0.020466	-56.92	314.95	682.64	374.58	-6.60

98	1310.29	0.022117	-56.37	315.83	682.52	374.90	-6.66
156	1310.29	0.022117	-56.37	315.84	682.52	374.90	-6.66
121	1310.31	0.022878	-56.25	315.83	682.44	374.90	-6.67
21	1310.39	0.001165	-57.26	314.95	684.98	374.14	-6.46
125	1310.39	0.001166	-57.26	314.95	684.98	374.14	-6.46
110	1310.42	0.001278	-57.13	314.94	684.89	374.15	-6.47
82	1310.56	0.001214	-57.33	314.95	685.29	374.07	-6.46
36	1310.88	0.023461	-56.03	315.81	683.07	374.73	-6.77
144	1311.72	0.001117	-56.97	314.93	686.09	374.08	-6.47
111	1311.76	0.021406	-56.00	315.74	683.77	374.86	-6.67
102	1312.24	0.001442	-56.69	315.83	685.22	374.36	-6.52
68	1312.74	0.024781	-56.07	314.86	685.98	374.49	-6.59
6	1313.07	0.022319	-56.23	318.78	682.02	375.06	-6.63
75	1314.5	0.00201	-56.31	314.85	688.32	374.04	-6.44
52	1315.83	0.015398	-55.45	315.25	684.16	376.44	-4.61
137	1317.4	0.001679	-56.06	318.78	686.46	374.68	-6.49
45	1318.75	0.001446	-56.99	322.63	685.41	374.17	-6.51
164	1321.17	0.023681	-55.89	326.33	682.19	375.16	-6.69
61	1322.41	0.002089	-56.29	322.62	688.13	374.40	-6.49
8	1322.46	0.002012	-56.29	322.59	687.94	374.35	-6.16
136	1328.09	0.001497	-54.99	314.92	699.29	375.21	-6.37
155	1328.88	0.000163	-54.64	323.08	689.99	376.40	-6.00
96	1329.6	0.000174	-54.69	315.45	693.24	380.03	-4.47
71	1333.7	1.83E-05	-54.37	314.22	731.08	348.76	-6.04
65	1334.2	0.031218	-54.26	326.20	693.05	375.28	-6.13
152	1335	1.83E-05	-54.08	314.21	732.15	348.74	-6.06
131	1335.76	2.06E-05	-53.79	314.91	732.10	348.50	-5.99
97	1339.61	2.11E-05	-55.14	314.66	733.31	352.69	-5.96
129	1339.61	2.11E-05	-55.14	314.66	733.31	352.69	-5.96
187	1339.61	2.11E-05	-55.14	314.66	733.31	352.69	-5.96
194	1339.61	2.11E-05	-55.14	314.66	733.31	352.69	-5.96
198	1339.61	2.11E-05	-55.14	314.66	733.31	352.69	-5.96
181	1339.66	2.11E-05	-55.01	314.65	733.27	352.68	-5.96
22	1339.8	2.11E-05	-55.22	314.67	733.66	352.61	-5.96
104	1340.06	2.37E-05	-55.21	314.63	734.43	352.03	-5.86
105	1340.06	2.37E-05	-55.21	314.63	734.43	352.03	-5.86
114	1340.06	2.37E-05	-55.21	314.63	734.43	352.03	-5.86
117	1340.06	2.37E-05	-55.21	314.63	734.43	352.03	-5.86
147	1340.06	2.37E-05	-55.21	314.63	734.43	352.03	-5.86
170	1340.06	2.37E-05	-55.21	314.63	734.43	352.03	-5.86
182	1340.06	2.37E-05	-55.21	314.63	734.43	352.03	-5.86
11	1341.16	2.09E-05	-54.52	315.41	733.18	353.05	-5.99
15	1341.16	2.09E-05	-54.52	315.41	733.18	353.05	-5.99

23	1341.16	2.09E-05	-54.52	315.41	733.18	353.05	-5.99
135	1341.16	2.09E-05	-54.52	315.41	733.18	353.05	-5.99
1	1341.22	2.09E-05	-54.40	315.40	733.15	353.03	-6.00
43	1341.61	2.34E-05	-54.59	315.38	734.30	352.38	-5.89
148	1341.61	2.34E-05	-54.59	315.37	734.30	352.38	-5.89
185	1342.26	2.38E-05	-54.47	314.59	736.05	351.89	-5.86
85	1343.81	2.36E-05	-53.85	315.33	735.92	352.25	-5.88
109	1343.91	1.97E-05	-54.02	314.84	734.37	353.02	-4.34
91	1343.98	2.12E-05	-53.59	315.35	735.27	352.88	-5.98
13	1344.4	2.33E-05	-54.44	318.34	733.77	352.55	-5.86
78	1344.4	2.33E-05	-54.44	318.34	733.77	352.55	-5.86
12	1345.46	1.55E-05	-53.46	314.12	737.53	353.60	-6.38
59	1345.98	2.14E-05	-53.22	315.20	737.05	352.86	-5.95
138	1348.45	2.07E-05	-54.91	322.33	734.92	351.99	-5.92
200	1348.51	2.19E-05	-54.12	314.53	739.20	353.80	-4.95
33	1350.49	2.08E-05	-54.36	323.06	735.44	352.28	-5.97
159	1352.45	1.86E-05	-54.16	325.95	733.54	353.11	-6.02
2	1352.74	2.09E-05	-54.15	325.92	734.32	352.52	-5.92
141	1352.93	2.09E-05	-54.23	325.93	734.67	352.44	-5.91
168	1355.25	1.2E-05	-52.66	322.06	736.76	355.80	-6.75
32	1389.5	1.24E-05	-48.47	321.47	757.58	357.67	1.21
149	1391.37	1.36E-05	-51.11	316.53	769.78	360.01	-3.88
173	1410.35	1.44E-05	-44.40	315.89	758.44	385.67	-5.28

Table 6. Time-series comparison of SSB, SSB/SPR30%, MSST, and F, and F/MFMT for the SEDAR 33 update model for greater amberjack. Fcurrent = geometric mean (F2013-2015) = 0.33, Fcurrent/MFMT=1.68).

Year	SSB	SSB/SSB_SPR30%	SSB/MSST	F	F/FSPR30%
1950	15,433	2.71	3.77	0.02	0.08
1951	15,546	2.73	3.80	0.02	0.09
1952	15,607	2.74	3.81	0.02	0.11
1953	15,603	2.74	3.81	0.03	0.13
1954	15,527	2.73	3.79	0.03	0.14
1955	15,383	2.71	3.76	0.03	0.16
1956	15,181	2.67	3.71	0.03	0.17
1957	14,949	2.63	3.65	0.04	0.18
1958	14,695	2.58	3.59	0.04	0.20
1959	14,425	2.54	3.52	0.04	0.21
1960	14,144	2.49	3.45	0.04	0.22
1961	13,858	2.44	3.38	0.05	0.23
1962	13,601	2.39	3.32	0.05	0.23
1963	13,374	2.35	3.27	0.05	0.24
1964	13,174	2.32	3.22	0.05	0.24
1965	13,002	2.29	3.18	0.05	0.24
1966	12,854	2.26	3.14	0.05	0.25
1967	12,712	2.24	3.10	0.05	0.26
1968	12,563	2.21	3.07	0.05	0.27
1969	12,420	2.18	3.03	0.06	0.28
1970	12,254	2.15	2.99	0.06	0.28
1971	12,108	2.13	2.96	0.06	0.31
1972	11,911	2.09	2.91	0.07	0.33
1973	11,595	2.04	2.83	0.07	0.36
1974	11,129	1.96	2.72	0.08	0.39
1975	10,545	1.85	2.58	0.09	0.43
1976	9,855	1.73	2.41	0.10	0.48
1977	9,081	1.60	2.22	0.11	0.55
1978	8,221	1.45	2.01	0.13	0.64
1979	7,288	1.28	1.78	0.15	0.74
1980	6,304	1.11	1.54	0.17	0.84
1981	5,358	0.94	1.31	0.11	0.54
1982	5,065	0.89	1.24	0.26	1.29
1983	4,399	0.77	1.07	0.17	0.85
1984	4,512	0.79	1.10	0.15	0.77
1985	4,670	0.82	1.14	0.23	1.17
1986	4,193	0.74	1.02	0.39	1.96



1987	3,022	0.53	0.74	0.54	2.74
1988	2,028	0.36	0.50	0.49	2.45
1989	1,737	0.31	0.42	0.68	3.42
1990	1,137	0.20	0.28	0.32	1.64
1991	1,364	0.24	0.33	0.74	3.74
1992	1,065	0.19	0.26	0.60	3.04
1993	1,050	0.18	0.26	0.72	3.60
1994	817	0.14	0.20	0.68	3.42
1995	714	0.13	0.17	0.51	2.57
1996	844	0.15	0.21	0.63	3.17
1997	822	0.14	0.20	0.52	2.63
1998	784	0.14	0.19	0.42	2.14
1999	823	0.14	0.20	0.41	2.06
2000	989	0.17	0.24	0.42	2.12
2001	1,093	0.19	0.27	0.38	1.89
2002	1,352	0.24	0.33	0.42	2.13
2003	1,743	0.31	0.43	0.54	2.71
2004	1,658	0.29	0.41	0.55	2.76
2005	1,279	0.22	0.31	0.53	2.65
2006	1,026	0.18	0.25	0.43	2.18
2007	1,020	0.18	0.25	0.34	1.72
2008	1,091	0.19	0.27	0.39	1.99
2009	1,151	0.20	0.28	0.47	2.36
2010	1,166	0.21	0.28	0.42	2.13
2011	1,264	0.22	0.31	0.31	1.57
2012	1,508	0.27	0.37	0.29	1.47
2013	1,649	0.29	0.40	0.34	1.69
2014	1,618	0.28	0.40	0.32	1.60
2015	1,640	0.29	0.40	0.35	1.77

Table 7. Management advice table from the SEDAR 33 update model and the SEDAR 33 benchmark model for greater amberjack.

Criteria	Definitions	SEDAR 33 Update	SEDAR 33
<b>M</b>		0.28	0.28
<b>Steepness</b>		0.85	0.85
<b>Virgin Recruitment</b>	1,000s	2,761	2,827
<b>SSB Unfished</b>		18,779	17,356
	<b>Mortality rate criteria</b>		
<b>Fmsy or proxy</b>	F_SPR30%	0.20	0.22
<b>MFMT</b>	F_SPR30%	0.20	0.22
<b>Fcurrent</b>	Geometric mean (F(nyr-3)-nyr)	0.33	0.26
<b>Fcurrent/MFMT</b>		1.69	1.15
	<b>Biomass criteria</b>		
<b>SSB_msy or proxy</b>	SSB_SPR30%	5,686	4,646
<b>MSST (Mtons)</b>	(1-M)*SSB_SPR30%	4,094	3,345
<b>SSBcurrent (Mtons)</b>	SSB2015	1,640	2,188
<b>SSBcurrent/SSB_SPR30%</b>	SSB2015	0.288	0.47
<b>SSBcurrent/MSST</b>	SSB2015	0.400	0.65
<b>OFL</b>	<b>Annual yield at MFMT (MP, ww) = FSPR30%</b>		
	OFL 2017	1.243	2.906
	OFL 2018	1.500	2.986
	OFL 2019	1.836	3.068
	OFL 2020	2.167	3.170
	OFL 2021	2.438	3.266
	OFL 2022	2.666	3.344
<b>ABC</b>	<b>Annual yield at FOY (MP, ww) = 75%FSPR30%</b>		
	ABC 2017	0.936	2.489
	ABC 2018	1.182	2.616
	ABC 2019	1.489	2.730
	ABC2020	1.794	2.852
	ABC 2021	2.057	2.964
	ABC 2022	2.287	3.058
<b>Alternative ABC</b>	<b>Annual yield (MP, ww) = FSPR40%</b>		
	2017	0.927	2.379
	2018	1.172	2.514
	2019	1.477	2.633
	2020	1.781	2.758
	2021	2.043	2.872
	2022	2.273	2.968

## Appendices SEDAR 33 Gulf of Mexico Greater Amberjack Update

### Appendix A.

#### RECREATIONAL LANDINGS AND DISCARDS ESTIMATION METHODS

Source: Matter, Vivian and Kelly Fitzpatrick. 2016. RecDoc\_SEDAR update\_ GOM gaj\_2016\_Final, 6pp. Unpublished document provided to Nancie Cummings 11/29/2016.

2016 SEDAR Update Gulf of Mexico greater amberjack

#### Recreational Landings

##### *Introduction*

The recreational landings for greater amberjack were obtained from the following separate sampling programs:

- 1) Marine Recreational Fisheries Statistics Survey (MRFSS) and the Marine Recreational Information Program (MRIP)
- 2) Southeast Region Headboat Survey (SRHS)
- 3) Texas Parks and Wildlife Department (TPWD)
- 4) LA Creel Survey

MRFSS/MRIP provides a long time series of estimated catch per unit effort, total effort, landings, and discards for six two-month periods (waves) each year. MRFSS/MRIP provides estimates for three recreational fishing modes: shore-based fishing (SH), private and rental boat fishing (PR), and for-hire charter and guide fishing (CH). When the survey first began in Wave 2 (Mar/Apr), 1981, headboats were included in the for-hire mode, but were excluded after 1985 in the South Atlantic and Gulf of Mexico to avoid overlap with the Southeast Region Headboat Survey (SRHS) conducted by the NMFS Beaufort, NC lab. The MRFSS/MRIP survey covers coastal Gulf of Mexico states from Florida to Louisiana. The state of Texas was included in the survey from 1981-1985, although not all modes and waves were covered.

The Southeast Region Headboat Survey (SRHS) estimates landings and effort for headboats in the South Atlantic and Gulf of Mexico. The SRHS began in the South Atlantic in 1972 and Gulf of Mexico in 1986 and extends from the North Carolina/Virginia border to the Texas/Mexico border. Mississippi headboats were added to the survey in 2010. The South Atlantic and Gulf of Mexico Headboat Surveys generally include 70-80 vessels participating in each region annually.

The TPWD Sport-boat Angling Survey was implemented in May 1983 and samples fishing trips made by sport-boat anglers fishing in Texas marine waters. All sampling takes place at recreational boat access sites. The raw data include information on catch, effort and length composition of the catch for sampled boat-trips. These data are used by TPWD to generate recreational catch and effort estimates. The survey is designed to estimate landings and effort by high-use (May 15-November 20) and low-use seasons (November 21-May 14). In SEDAR 16 TPWD seasonal data was disaggregated into months. Since then SEFSC personnel has disaggregated the TPWD seasonal estimates into waves (2 month periods) using the TPWD intercept data. This was done to make the TPWD time series compatible with

the MRFSS/MRIP time series. TPWD surveys private and charterboat fishing trips. While TPWD samples all trips (private, charterboat, ocean, bay/pass), most of the sampled trips are associated with private boats fishing in bay/pass, as these trips represent most of the fishing effort. Charterboat trips in ocean waters are the least encountered in the survey.

The Louisiana Department of Wildlife and Fisheries (LDWF) began conducting the Louisiana Creel (LA Creel) survey program for monitoring marine recreational fishery catch and effort on January 1, 2014. Private and charter modes of fishing are sampled. The program is comprised of three separate surveys: a shoreside intercept survey, a private telephone survey, and a for-hire telephone survey. The shoreside survey is used to collect data needed to estimate the mean numbers of fish landed by species for each of five different inshore basins and one offshore area. The private telephone survey samples from a list of people who possess either a LA fishing license or a LA offshore fishing permit and provided a valid telephone number. The for-hire telephone survey samples from a list of Louisiana's registered for-hire captains who provided a valid telephone number. Both telephone surveys are conducted weekly. No information is collected on released fish.

#### *Adjustments and modifications*

- The For-Hire Telephone Survey (FHS) was developed to estimate effort in the for-hire mode. Conversion factors have been estimated to calibrate the traditional MRFSS charter boat estimates with the FHS for 1986-1997 in the Gulf of Mexico (SEDAR7-AW-03). To calibrate the MRFSS combined charter boat and headboat mode effort estimates in 1981-1985, conversion factors were estimated using 1986-1990 effort estimates from both modes, in equivalent effort units, an angler trip (SEDAR28-DW-12). These conversion factors are the same as those used in SEDAR 33.
- Estimated landings of unidentified jack (Carangidae and *Seriola* spp.) in the earlier years of the MRFSS database are considerable. Because some of these landings are likely to be greater amberjack landings, it was necessary to estimate what proportion of the unidentified landings are actually greater amberjack. SEDAR 33 ratios of greater amberjack over identified amberjacks and jacks by year groups were applied in this update.
- The Marine Recreational Information Program (MRIP) was developed to generate more accurate recreational catch rates by re-designing the MRFSS sampling protocol to address potential biases including port activity and time of day. Starting in 2013, wave 2, the MRIP Access Point Angler Intercept Survey (APAIS) implemented a revised sampling design. As new MRIP APAIS estimates are available for a portion of the recreational time series that the MRFSS covers, conversion factors between the MRFSS estimates and the MRIP APAIS estimates were developed in order to maintain one consistent time series for the recreational catch estimates. Ratio estimators, based on the ratios of the means, were developed for Gulf of Mexico greater amberjack to hind-cast catch and variance estimates by fishing mode. In order to apply the charter boat ratio estimator back in time to 1981, charter boat landings were isolated from the combined charter boat/headboat mode for 1981-1985. The MRFSS to MRIP APAIS calibration process is the same as the original MRFSS to MRIP adjustment that has been used since

2012, which is detailed in SEDAR31-DW25 and SEDAR32-DW02. In SEDAR 33, MRIP estimation adjustment factors were used to maintain a consistent time series of recreational catch. In this update MRIP APAIS adjustment factors, shown in Table 1 below are used to reflect the most current methodologies.

- **Table 1.** Gulf of Mexico greater amberjack ratio estimators for adjusting MRFSS numbers and variance estimates (AB1 and B2) to MRIP APAIS numbers and variances for 1981-2003. The variances of the numbers ratio estimators are also shown.

MODE	Numbers Ratio Estimator		Variance Ratio Estimator		Variance of Numbers Ratio Estimator	
	AB1	B2	AB1	B2	AB1	B2
Charter boat	0.997744	0.929471	4.780032	4.414711	0.000233	0.002894758
Private	1.348462	2.215803	9.122366	62.64771	0.01019	0.154247981
Shore		0.602731		0.603091		0.002480734
All	1.166712	1.815156	8.364642	51.576322	0.002513	0.084765059

- The MRFSS and the MRIP surveys use different methodologies to estimate landings in weight. To apply a consistent methodology over the entire recreational time series, the Southeast Fisheries Science Center (SEFSC) implemented a method for calculating average weights for the MRIP (and MRIP adjusted) landings. This method is detailed in SEDAR32-DW-02. The length-weight equation from SEDAR 33 ( $W=6.904E-5*(L^{2.638})$ ) was used to convert greater amberjack sample lengths into weights, when no weight was recorded. W is whole weight in kilograms and L is fork length in centimeters. This method was used to calculate landings estimates in weight from the MRIP, TPWD, and LA Creel programs.
- Following SEDAR 33 recommendations, Monroe County estimates were excluded from the Gulf of Mexico and included in the South Atlantic stock. Monroe County MRFSS landings from 1981 to 2003 can be post-stratified to separate them from the MRFSS West Florida estimates. Originally, during the first MRIP re-estimation (applied in SEDAR 33), Monroe County landings (2004+) could be estimated separately from the remaining West Florida estimates using domain estimation. The Monroe County domain includes only intercepted trips returning to that county as identified in the intercept survey data. Estimates are then calculated within this domain using standard design-based estimation which incorporates the MRIP design stratification, clustering, and sample weights. However, the new MRIP APAIS calibration does not allow for domain estimation at this time for adjusted estimates from 2004 to 2012. The approach used for this update is to use the annual proportions from the original MRIP domain estimates (panhandle and

peninsula over total FLW) and apply those proportions to the new West Florida MRIP APAIS estimates in order to remove Monroe County. This approach was also used in SEDAR 42, Gulf of Mexico red grouper. Traditional MRIP domain estimation is available for estimates 2013+ and is used in this update to exclude Monroe County for that time period.

- There was a change in the 1987 post-stratified estimates since SEDAR 33. During 1987 sampling in West Florida (Monroe – Escambia county) was stratified to increase sample size in Monroe county in Wave 1, and in the western panhandle (Escambia to Bay county) in Waves 3-5. Catch and effort estimates were generated for these regions separate from the rest of West Florida, designated with  $st=90$ , then aggregated to report the ‘state’ totals for all of West Florida ( $st=12$ ). An error was discovered in the previous post-stratified program that failed to correctly convert effort estimates from  $st=90$  to  $st=12$  before being merged with the intercept data. This error was discovered in February 2015 and corrected. The resulting, corrected 1987 post-stratified estimates are included in this SEDAR update for greater amberjack.
- 
- Following SEDAR 9 and 33 recommendations, shore mode MRFSS/MRIP greater amberjack estimates were excluded.
- Missing estimates from MRIP 1981, wave 1 have been filled in using the proportion of catch in wave 1 to catch in all other waves for 1982-1984 by fishing mode and area.
- Variances are provided by MRFSS/MRIP for their recreational catch estimates. Variances are adjusted to take into account the variance of the conversion factor when an adjustment to the estimate has been made (FHS and MRIP conversions). However, the variance estimates of the charter and headboat modes in 1981-1985 are missing. This is due to the MRIP calibration procedure, which requires the combined charter/headboat mode to be split in order to apply the MRIP adjustment to the charter mode back to 1981. In addition, variance estimates are not available for weight estimates generated through the SEFSC method described above.
- Headboat landing estimates from 1981-1985 come from the MRFSS/MRIP survey for all states except Texas. Following SEDAR 33 recommendations, headboat landings for Texas 1981 to 1985 were estimated using a 3yr average (1986-1988) from SRHS Texas landings.
- The SRHS was inconsistent in LA in 2002-2006. There were no trip reports collected in LA in 2002. Trip reports from 2001 were used (by the HBS) as a substitute to generate estimates of numbers caught (though there are some minor differences between the resulting estimates for the two years). In 2003, there were only a few trip reports but they were still used to generate the estimates. From 2004 to 2006 there were no trip reports or fish sampled, and no substitutes were used, so there are no estimates or samples from 2004 to 2006 due to funding issues and Hurricane Katrina. However, the MRFSS/MRIP For-Hire Survey included the LA headboats in their charter mode estimates for these years thereby eliminating this hole in the headboat mode estimates.

- Texas data from the MRFSS is only available from 1981-1985 and is sporadic, not covering all modes and waves. For these reasons, Texas boat mode estimates from the MRFSS were not included. Instead, averages from TPWD 1983-1985 by mode and wave were used to fill in these modes prior to the start of the TPWD survey in May 1983.
- LA Creel landings estimates were used for LA 2014 when MRIP estimates are missing.

### **Recreational Discards**

Discarded live fish are reported by the anglers interviewed by the MRIP/MRFSS. Consequently, neither the identity nor the quantities reported are verified. MRFSS/MRIP estimates of live released fish (B2 fish) were adjusted in the same manner as the landings (i.e., using charter boat calibration factors, MRIP adjustment, substitutions, etc. described in section above).

SRHS discards are available from 2004 to the present. In 2013 the SRHS ceased recording the condition of released fish (live vs dead). All releases are recorded as "Estimated alive" starting that year. For consistency, all discards from 2004 to 2012 are categorized as b2 fish (released alive). SRHS discard estimates were not used in SEDAR 33, therefore a proxy method was used to estimate headboat discards in all years (1986-2015). Headboat discard estimates for 1986-2015 were provided using two different proxy methods:

- 1) MRIP CH proxy method: Apply the yearly Gulf-wide MRFSS charter boat discard:landings ratio to estimated headboat landings in order to estimate headboat discards from 1986-2015. It was assumed that headboat discards in TX were negligible. This method is consistent with SEDAR 33.
- 2) SRHS:MRIP CH ratio proxy method (Best Practices approved): Calculate a ratio of the mean ratio of SRHS discard:landings (2004-2015) and MRIP CH discard:landings (2004-2015). Apply this ratio to the yearly MRIP charter boat discard:landings ratio (1986-2015) in order to determine the yearly SRHS discard:landings ratio (1986-2015). This ratio is then applied to the SRHS landings (1986-2015) in order to estimate headboat discards (1986-2015). It was assumed that headboat discards in TX were negligible.

The preferred method was Option 1, to maintain consistency with SEDAR 33.

## Literature Cited

Diaz, G.A. and P.L. Phares. 2004. SEDAR7-AW03 Estimating conversion factors for calibrating MRFSS charterboat landings and effort estimates for the Gulf of Mexico in 1981-1997 with For-Hire Survey estimates with application to red snapper landings. National Marine Fisheries Service Southeast Fisheries Science Center, Sustainable Fisheries Division, Miami, FL.

Matter, V.M. and A. Rios 2013. SEDAR 32-DW02 MRFSS to MRIP Adjustment Ratios and Weight Estimation Procedures for South Atlantic and Gulf of Mexico Managed Species. National Marine Fisheries Service Southeast Fisheries Science Center, Fisheries Statistics Division, Miami, FL., National Marine Fisheries Service Southeast Fisheries Science Center, Sustainable Fisheries Division, Miami, FL.

Matter, V.M., N. Cummings, J.J. Isely, K. Brennan, and K. Fitzpatrick. 2012. SEDAR 28-DW-12 Estimated conversion factors for calibrating MRFSS charterboat landings and effort estimates for the South Atlantic and Gulf of Mexico in 1981-1985 with For Hire Survey estimates with application to Spanish mackerel and cobia landings. National Marine Fisheries Service Southeast Fisheries Science Center, Sustainable Fisheries Division, Miami, FL., National Marine Fisheries Service Southeast Fisheries Science Center, Fisheries Statistics Division, Miami, FL, and National Marine Fisheries Service Southeast Fisheries Science Center, Beaufort Laboratory, Beaufort, NC.

Rios, A, V.M. Matter, J.F. Walter, N. Farmer, and S.J. Turner. 2012. SEDAR31-DW25 Estimated Conversion Factors for Adjusting MRFSS Gulf of Mexico Red Snapper Catch Estimates and Variances in 1981-2003 to MRIP Estimates and Variances. National Marine Fisheries Service Southeast Fisheries Science Center, Sustainable Fisheries Division, Miami, FL, National Marine Fisheries Service Southeast Fisheries Science Center, Fisheries Statistics Division, Miami, FL, and National Marine Fisheries Service Southeast Regional Office, Saint Petersburg, FL.

SEDAR. 2014. SEDAR 33 – Gulf of Mexico Greater Amberjack Stock Assessment Report. SEDAR, North Charleston SC. Available online at:

<http://sedarweb.org/sedar-33-stock-assessment-report-gulf-mexico-greater-amberjack>



## Appendix B.

### Standardized Catch Rate Indices for Gulf of Mexico Greater Amberjack (*Seriola dumerili*) Commercial Handline and Longline Fisheries, 1990-2015

Daniel Goethel and Adyan Rios, NMFS, SEFSC, Miami Laboratory

Standardized catch rate indices (Catch-per-Unit Effort; CPUE) were developed independently for the commercial handline (vertical line) and longline fisheries across the entire Gulf of Mexico. The methods outlined at the 2013 SEDAR 33 benchmark (see SEDAR 33-AW18) were used to update each index through the terminal year of the 2016 SEDAR 33 Update (i.e., 2015). Due to the increasing length of commercial closed seasons and the apparent shifts in fishery targeting since 2010, an alternate set of indices was also developed that split the timeseries in 2010.

#### Data

- The National Marine Fisheries Service (NMFS) Gulf of Mexico (GoM) reef fish logbook data set (1990 – 2015) was utilized.
- Data was filtered to exclude any trips that appeared to be incorrectly reported.
- The handline index included only trips that targeted greater amberjack.
- Data from statistical areas 2-21 (Gulf of Mexico excluding the Florida Keys) were used.
- Data was excluded from closed seasons (after quota was met and fishery was shut down).

#### Analysis

- A single abundance index was developed for each fishery across the entire Gulf of Mexico.
- The Stephens and MacCall (SM; 2004) method was applied to identify and remove trips that were unlikely to have occurred in greater amberjack habitat based on logistic regression of species presence/absence.
- A two-stage delta lognormal model (Lo et al. 1992) was applied to remove the influence of extraneous factors, which consisted of a binomial generalized linear model (GLM) on the proportion of positive trips and a normal GLM on the log of CPUE (fish caught/total hours fished).
- Stepwise variable selection was utilized where factor significance was based on AIC criteria and percent deviance explained (factors were only included if deviance explained > 1%).
- Two-way interaction terms were examined for significant factors where interactions with the year variable were included as random effects.
- The *Year* variable was forced to be in all models.
- The program was implemented using the SAS macro, GLIMMIX (Little et al. 1996).
- In the 2013 Benchmark, the commercial CPUE indices were truncated in 2010 despite a 2012 terminal year, because of the impact of extended closed seasons on model results.
- For the 2016 Update the entire timeseries was utilized (1990-2015), but similar pitfalls of using data from years where fishing season was shortened due to management regulations will be present.
- A second suite of indices were developed to account for the extended closed seasons

caused by quota limitations since 2011 where each index was split in 2010 and independent indices were developed from 1990-2010 and 2011-2015.

## Results

- Tables 1 (handline) and 2 (longline) provide the total trips after logbook filtering and SM trip selection, while Figure 1 illustrates yearly proportion of positive trips and Figures 2-3 give SM model diagnostics.
- The final binomial models were:
  - Handline:  $Proportion\ Positive = Year + Area + Crew\ Size + Year*Area$
  - Longline:  $Proportion\ Positive = Year + Area + Away\ Time$
  - Differences from the final 2013 models included the inclusion of *Away Time* as a significant factor for the 2016 Update longline model and the lack of *Away Time* as a significant factor in the Update handline model (all other chosen factors were consistent with the 2013 Benchmark).
- The final normal models were:
  - Handline:  $\ln(CPUE) = Year + Area + Year*Area$
  - Longline:  $\ln(CPUE) = Year + Area + Year*Area$
  - These models were consistent with the 2013 Benchmark models
- Tables 3 (handline) and 4 (longline) provide the final CPUE indices including CVs and nominal CPUE, while final indices are also provided in Figures 4-5.
- Final model diagnostics are provided in Figures 6-7.
- Figures 8-9 provide a comparison to the final 2013 Benchmark indices where each index was normalized to its mean over a common time period (1990-2010).
- Tables 5 (handline) and 6 (longline) provide the total trips after logbook filtering and SM trip selection for the split series indices, while Figure 10 illustrates yearly proportion of positive trips and Figures 11-12 give SM model diagnostics.
- The final split series binomial models for 1990-2010 were:
  - Handline:  $Proportion\ Positive = Year + Area + Crew\ Size$
  - Longline:  $Proportion\ Positive = Year + Area$
- The final split series binomial models for 2011-2015 were:
  - Handline:  $Proportion\ Positive = Year + Quarter + Away\ Time + Area + Crew\ Size$
  - Longline:  $Proportion\ Positive = Year + Season + Area$
- The final split series normal models for 1990-2010 were:
  - Handline:  $\ln(CPUE) = Year + Area + Year*Area$
  - Longline:  $\ln(CPUE) = Year + Area + Year*Area$
- The final split series normal models for 2011-2015 were:
  - Handline:  $\ln(CPUE) = Year + Quarter + Area + Year*Quarter$
  - Longline:  $\ln(CPUE) = Year + Area$
- Tables 7 (handline) and 8 (longline) provide the final split series CPUE indices including CVs and nominal CPUE, while final indices are also provided in Figures 13-14.
- Final split series model diagnostics are provided in Figures 15-16.
- Figures 17-18 provide a comparison to the full timeseries indices where each index in normalized to its mean over a common time period (1990-2010 and 2011-2015).

## Discussion

The final base CPUE indices for both the handline and longline fisheries were relatively flat until the mid-2000s where elevated levels of CPUE were seen. Slight declines then occurred until 2010 at which point the two indices diverged. The handline index underwent a 4-fold increase, while the longline index indicated a similar decline. Both indices have fluctuated around their respective high or low levels over the last 5 years. Both models had good model fit and did not indicate any problematic diagnostics. The drastic inverse trends since 2010 is due to the rapid decrease in positive trips and, conversely, increase in positive trips for the longline and handline fisheries, respectively. The reason for these trends is most likely due to the decreased season lengths caused by quota limitations since 2010, which has clearly caused a change in fishermen targeting practices for greater amberjack.

At the 2013 SEDAR 33 Benchmark, the decision was made to truncate the commercial CPUE indices in 2010 in order to avoid including years with vastly shortened seasons and potentially different targeting behavior. Given the rapid changes in the indices seen since 2010, it may not be appropriate to use the full commercial CPUE time series. For this reason, split series indices were developed for both fisheries. Each series was split after 2010 to allow two time series that were believed to have similar targeting and season lengths. The historical time series (1990-2010) contained only years that were not significantly shortened due to quota limitations, while the recent time series (2011-2015) contained only years that were shortened. The short recent time series for both the handline and longline fisheries suffered from relatively low sample sizes and few data points from which to estimate the GLM parameters. Not surprisingly these models showed some troubling diagnostics. However, the new split series indices show much better consistency across fisheries compared to the full time series base model, which is likely to improve the performance of the resulting stock assessment.

Further research is warranted to investigate the potential for including a new GLM factor that accounts for the management regulations, which have resulted in the shortened greater amberjack fishing seasons. However, given the complexities of current management regimes in the Gulf of Mexico, it may not be feasible to effectively standardize commercial CPUE. For the 2016 greater amberjack Update, three scenarios are possible for including commercial CPUE: truncate the time series in 2010 as was done in SEDAR 33, use the full time series or split the series in 2010. None of the approaches present an ideal situation as they do not directly standardize catch rates for the processes leading to the divergent indices (i.e., when the full timeseries is utilized).

#### LITERATURE CITED

- Littell, R.C., G.A. Milliken, W.W. Stroup, and R.D Wolfinger. 1996. SAS® System for Mixed Models, Cary NC, USA:SAS Institute Inc., 1996. 663 pp.
- Lo, N.C., Jacobson, L.D., and Squire, J.L. 1992. Indices of relative abundance from fish spotter data based on delta-lognormal models. *Can. J. Fish. Aquat. Sci.* 49: 2515-2526.
- Stephens, A., and MacCall, A. 2004. A multispecies approach to subsetting logbook data for purposes of estimating CPUE. *Fish. Res.* 70: 299-310.

**TABLES**

**Table 1:** Total trips, positive trips, and proportion of positive trips before (Total) and after trip selection (Stephens and MacCall) for greater amberjack from the handline fishery. The proportion of trips retained is also provided.

Year	Total			Stephens and MacCall			
	Positive	Total	Proportion Positive	Positive	Total	Proportion Positive	Proportion of Trips Retained
1990	143	1096	0.13	39	186	0.21	0.17
1991	206	1224	0.17	76	187	0.41	0.15
1992	215	1728	0.12	84	281	0.30	0.16
1993	476	3291	0.14	207	521	0.40	0.16
1994	492	3742	0.13	223	522	0.43	0.14
1995	572	4200	0.14	259	642	0.40	0.15
1996	629	3932	0.16	278	647	0.43	0.16
1997	724	5617	0.13	311	726	0.43	0.13
1998	554	4854	0.11	231	562	0.41	0.12
1999	547	5645	0.10	239	513	0.47	0.09
2000	517	5592	0.09	177	386	0.46	0.07
2001	509	5620	0.09	199	502	0.40	0.09
2002	608	5700	0.11	236	634	0.37	0.11
2003	704	5403	0.13	272	553	0.49	0.10
2004	627	4682	0.13	213	452	0.47	0.10
2005	531	3897	0.14	188	442	0.43	0.11
2006	392	3848	0.10	187	361	0.52	0.09
2007	246	3341	0.07	99	210	0.47	0.06
2008	271	3163	0.09	103	224	0.46	0.07
2009	246	3095	0.08	57	137	0.42	0.04
2010	158	1592	0.10	41	92	0.45	0.06
2011	121	1111	0.11	47	70	0.67	0.06
2012	73	454	0.16	27	51	0.53	0.11
2013	139	649	0.21	55	85	0.65	0.13
2014	188	1558	0.12	63	103	0.61	0.07
2015	190	1042	0.18	66	90	0.73	0.09

**Table 2:** Total trips, positive trips, and proportion of positive trips before (Total) and after trip selection (Stephens and MacCall) for greater amberjack from the longline fishery. The proportion of trips retained is also provided.

Year	Total			Stephens and MacCall			
	Positive	Total	Proportion Positive	Positive	Total	Proportion Positive	Proportion of Trips Retained
1990	58	330	0.18	30	64	0.47	0.19
1991	89	389	0.23	58	95	0.61	0.24
1992	79	359	0.22	45	73	0.62	0.20
1993	152	662	0.23	75	142	0.53	0.21
1994	209	958	0.22	118	227	0.52	0.24
1995	205	1118	0.18	110	214	0.51	0.19
1996	142	908	0.16	62	126	0.49	0.14
1997	265	1277	0.21	136	277	0.49	0.22
1998	183	866	0.21	101	211	0.48	0.24
1999	204	1021	0.20	112	209	0.54	0.20
2000	190	924	0.21	99	207	0.48	0.22
2001	205	970	0.21	106	180	0.59	0.19
2002	228	962	0.24	108	164	0.66	0.17
2003	293	1038	0.28	167	247	0.68	0.24
2004	209	1113	0.19	106	170	0.62	0.15
2005	229	1026	0.22	108	153	0.71	0.15
2006	259	1036	0.25	116	168	0.69	0.16
2007	165	610	0.27	82	126	0.65	0.21
2008	201	593	0.34	99	142	0.70	0.24
2009	93	225	0.41	69	105	0.66	0.47
2010	57	247	0.23	25	66	0.38	0.27
2011	37	320	0.12	20	105	0.19	0.33
2012	14	363	0.04	7	103	0.07	0.28
2013	17	439	0.04	9	74	0.12	0.17
2014	35	411	0.09	20	90	0.22	0.22
2015	44	511	0.09	29	113	0.26	0.22

**Table 3:** Gulf of Mexico greater amberjack standardized CPUE index values, coefficients of variation, 95% confidence limits, and nominal CPUE values from the handline fishery developed with target only trips.

<b>Year</b>	<b>Standardized Index</b>	<b>CV</b>	<b>Lower 95% CI</b>	<b>Upper 95% CI</b>	<b>Nominal CPUE</b>
1990	0.2416	0.7125	0.0671	0.8702	0.0547
1991	0.3275	0.6233	0.1041	1.0301	0.1308
1992	0.2541	0.6688	0.0753	0.8573	0.2311
1993	0.3238	0.5913	0.1083	0.9680	0.1460
1994	0.3475	0.5919	0.1161	1.0401	0.1779
1995	0.3172	0.5956	0.1054	0.9548	0.1023
1996	0.4103	0.5865	0.1383	1.2170	0.2297
1997	0.3547	0.5849	0.1199	1.0496	0.1990
1998	0.3437	0.5935	0.1146	1.0310	0.2485
1999	0.3455	0.5896	0.1159	1.0299	0.5194
2000	0.4125	0.5989	0.1363	1.2482	0.4149
2001	0.3533	0.6049	0.1156	1.0795	0.2916
2002	0.4025	0.6033	0.1321	1.2264	0.3434
2003	0.7636	0.5808	0.2598	2.2449	0.5019
2004	0.6927	0.5879	0.2330	2.0595	0.6637
2005	0.4374	0.5972	0.1449	1.3200	0.3984
2006	0.4788	0.5874	0.1612	1.4226	0.4154
2007	0.3135	0.6242	0.0995	0.9873	0.1889
2008	0.3656	0.6276	0.1155	1.1575	0.4866
2009	0.3230	0.6853	0.0934	1.1173	0.3205
2010	0.7842	0.7047	0.2202	2.7925	0.5025
2011	4.4982	0.7177	1.2392	16.3282	5.6004
2012	3.0850	0.7738	0.7839	12.1411	2.8987
2013	2.8822	0.6796	0.8405	9.8840	5.2269
2014	2.6587	0.6804	0.7743	9.1296	2.6515
2015	4.2829	0.6436	1.3195	13.9014	3.0553

**Table 4:** Gulf of Mexico greater amberjack standardized CPUE index values, coefficients of variation, 95% confidence limits, and nominal CPUE values from the longline fishery.

Year	Standardized Index	CV	Lower 95% CI	Upper 95% CI	Nominal CPUE
1990	0.6538	0.3969	0.3042	1.4051	1.1014
1991	0.8939	0.3030	0.4942	1.6169	1.1045
1992	1.6523	0.3241	0.8782	3.1086	2.0476
1993	0.6913	0.2827	0.3970	1.2037	1.0860
1994	0.4187	0.2687	0.2470	0.7100	1.2915
1995	0.6475	0.2765	0.3763	1.1143	1.1184
1996	0.5279	0.2980	0.2946	0.9459	0.3140
1997	0.7246	0.2643	0.4310	1.2184	0.5353
1998	0.7473	0.2717	0.4382	1.2744	3.7559
1999	0.7146	0.2682	0.4218	1.2106	0.7410
2000	0.7337	0.2738	0.4286	1.2563	0.5240
2001	0.8930	0.2678	0.5275	1.5116	0.8016
2002	1.1617	0.2668	0.6876	1.9626	0.7192
2003	1.3573	0.2551	0.8214	2.2428	0.9342
2004	1.5155	0.2667	0.8972	2.5598	1.0218
2005	2.3022	0.2650	1.3673	3.8762	1.4786
2006	1.5475	0.2642	0.9205	2.6015	0.8116
2007	1.2797	0.2774	0.7423	2.2062	1.0532
2008	1.7756	0.2691	1.0464	3.0128	1.2153
2009	2.1607	0.2827	1.2409	3.7620	1.5719
2010	1.6544	0.3803	0.7933	3.4503	0.8363
2011	0.2727	0.4091	0.1242	0.5989	0.1893
2012	0.3460	0.5979	0.1145	1.0455	0.4325
2013	0.5848	0.5449	0.2109	1.6214	0.3830
2014	0.2541	0.4085	0.1158	0.5575	0.3626
2015	0.5102	0.3638	0.2521	1.0326	0.7664

**Table 5:** Split series total trips, positive trips, and proportion of positive trips before (Total) and after trip selection (Stephens and MacCall) for greater amberjack from the handline fishery. The proportion of trips retained is also provided. The horizontal line separates values from the two independent indices (i.e., 1990-2010 and 2011-2015). Trip selection was carried out independently for each index.

Year	Total			Stephens and MacCall			
	Positive	Total	Proportion Positive	Positive	Total	Proportion Positive	Proportion of Trips Retained
1990	143	1096	0.13	42	175	0.24	0.16
1991	206	1224	0.17	78	187	0.42	0.15
1992	215	1728	0.12	86	268	0.32	0.16
1993	476	3291	0.14	203	510	0.40	0.15
1994	492	3742	0.13	228	511	0.45	0.14
1995	572	4200	0.14	247	615	0.40	0.15
1996	629	3932	0.16	277	635	0.44	0.16
1997	724	5617	0.13	312	708	0.44	0.13
1998	554	4854	0.11	231	540	0.43	0.11
1999	547	5645	0.10	239	496	0.48	0.09
2000	517	5592	0.09	175	379	0.46	0.07
2001	509	5620	0.09	200	491	0.41	0.09
2002	608	5699	0.11	232	610	0.38	0.11
2003	704	5399	0.13	270	544	0.50	0.10
2004	627	4681	0.13	208	442	0.47	0.09
2005	531	3897	0.14	198	455	0.44	0.12
2006	392	3848	0.10	189	382	0.49	0.10
2007	243	3336	0.07	105	219	0.48	0.07
2008	271	3157	0.09	108	229	0.47	0.07
2009	250	3519	0.07	57	176	0.32	0.05
2010	160	2132	0.08	42	115	0.37	0.05
2011	144	2373	0.06	67	127	0.53	0.05
2012	74	2224	0.03	29	101	0.29	0.05
2013	145	2249	0.06	58	125	0.46	0.06
2014	191	2865	0.07	102	222	0.46	0.08
2015	195	2872	0.07	116	199	0.58	0.07



**Table 6:** Split series total trips, positive trips, and proportion of positive trips before (Total) and after trip selection (Stephens and MacCall) for greater amberjack from the longline fishery. The proportion of trips retained is also provided. The horizontal line separates values from the two independent indices (i.e., 1990-2010 and 2011-2015). Trip selection was carried out independently for each index.

Year	Total			Stephens and MacCall			
	Positive	Total	Proportion Positive	Positive	Total	Proportion Positive	Proportion of Trips Retained
1990	58	330	0.18	27	62	0.44	0.19
1991	89	389	0.23	54	90	0.60	0.23
1992	79	359	0.22	46	70	0.66	0.19
1993	152	668	0.23	84	162	0.52	0.24
1994	210	966	0.22	119	232	0.51	0.24
1995	206	1127	0.18	121	241	0.50	0.21
1996	142	912	0.16	65	141	0.46	0.15
1997	266	1285	0.21	142	295	0.48	0.23
1998	184	872	0.21	108	230	0.47	0.26
1999	206	1025	0.20	118	227	0.52	0.22
2000	192	930	0.21	107	227	0.47	0.24
2001	205	970	0.21	119	208	0.57	0.21
2002	228	962	0.24	119	188	0.63	0.20
2003	299	1045	0.29	186	277	0.67	0.27
2004	216	1120	0.19	123	198	0.62	0.18
2005	229	1027	0.22	124	182	0.68	0.18
2006	262	1039	0.25	138	201	0.69	0.19
2007	170	615	0.28	101	159	0.64	0.26
2008	203	596	0.34	123	182	0.68	0.31
2009	93	226	0.41	74	118	0.63	0.52
2010	57	237	0.24	31	84	0.37	0.35
2011	36	317	0.11	9	26	0.35	0.08
2012	14	359	0.04	5	28	0.18	0.08
2013	17	437	0.04	5	26	0.19	0.06
2014	35	410	0.09	12	30	0.40	0.07
2015	42	503	0.08	21	52	0.40	0.10

**Table 7:** Split series Gulf of Mexico greater amberjack standardized CPUE index values, coefficients of variation, 95% confidence limits, and nominal CPUE values from the handline fishery developed with target only trips. The horizontal line separates values from the two independent indices (i.e., 1990-2010 and 2011-2015). Index development and variable selection was carried out independently for each index.

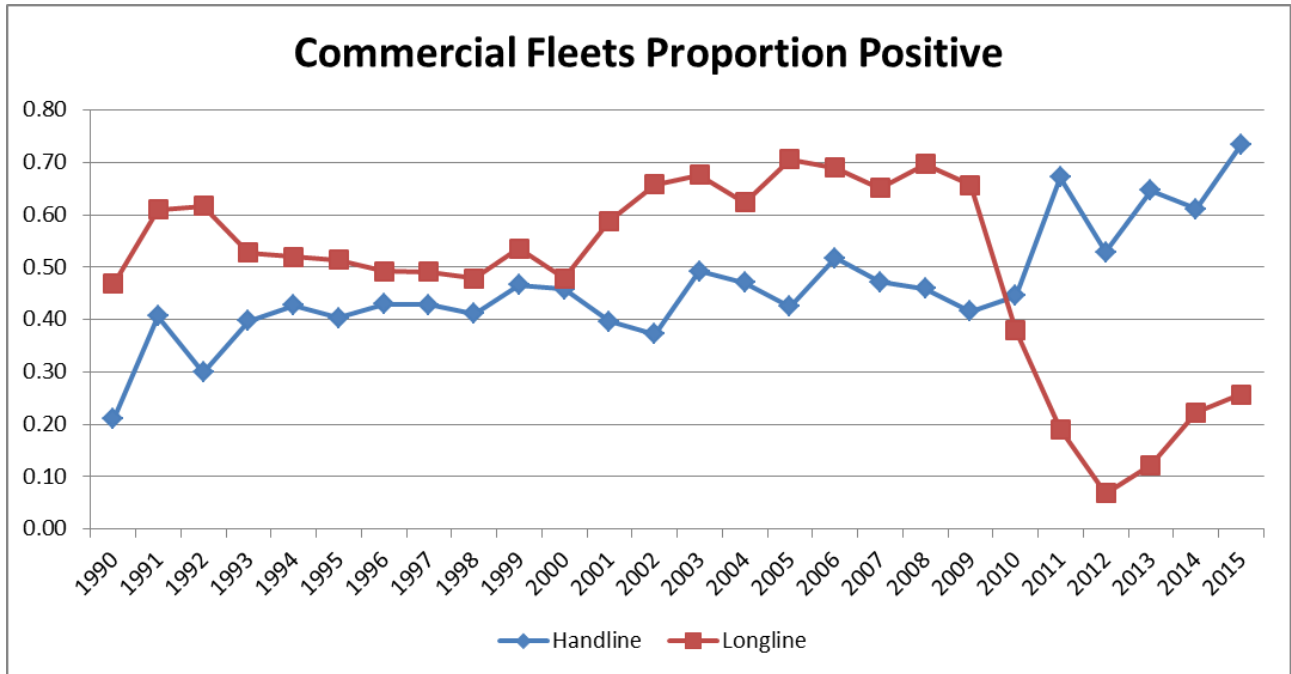
Year	Standardized Index	CV	Lower 95% CI	Upper 95% CI	Nominal CPUE
1990	0.2416	0.7125	0.0671	0.8702	0.0547
1991	0.3275	0.6233	0.1041	1.0301	0.1308
1992	0.2541	0.6688	0.0753	0.8573	0.2311
1993	0.3238	0.5913	0.1083	0.9680	0.1460
1994	0.3475	0.5919	0.1161	1.0401	0.1779
1995	0.3172	0.5956	0.1054	0.9548	0.1023
1996	0.4103	0.5865	0.1383	1.2170	0.2297
1997	0.3547	0.5849	0.1199	1.0496	0.1990
1998	0.3437	0.5935	0.1146	1.0310	0.2485
1999	0.3455	0.5896	0.1159	1.0299	0.5194
2000	0.4125	0.5989	0.1363	1.2482	0.4149
2001	0.3533	0.6049	0.1156	1.0795	0.2916
2002	0.4025	0.6033	0.1321	1.2264	0.3434
2003	0.7636	0.5808	0.2598	2.2449	0.5019
2004	0.6927	0.5879	0.2330	2.0595	0.6637
2005	0.4374	0.5972	0.1449	1.3200	0.3984
2006	0.4788	0.5874	0.1612	1.4226	0.4154
2007	0.3135	0.6242	0.0995	0.9873	0.1889
2008	0.3656	0.6276	0.1155	1.1575	0.4866
2009	0.3230	0.6853	0.0934	1.1173	0.3205
2010	0.7842	0.7047	0.2202	2.7925	0.5025
2011	4.4982	0.7177	1.2392	16.3282	5.6004
2012	3.0850	0.7738	0.7839	12.1411	2.8987
2013	2.8822	0.6796	0.8405	9.8840	5.2269
2014	2.6587	0.6804	0.7743	9.1296	2.6515
2015	4.2829	0.6436	1.3195	13.9014	3.0553

**Table 8:** Split series Gulf of Mexico greater amberjack standardized CPUE index values, coefficients of variation, 95% confidence limits, and nominal CPUE values from the longline fishery. The horizontal line separates values from the two independent indices (i.e., 1990-2010 and 2011-2015). Index development and variable selection was carried out independently for each index.

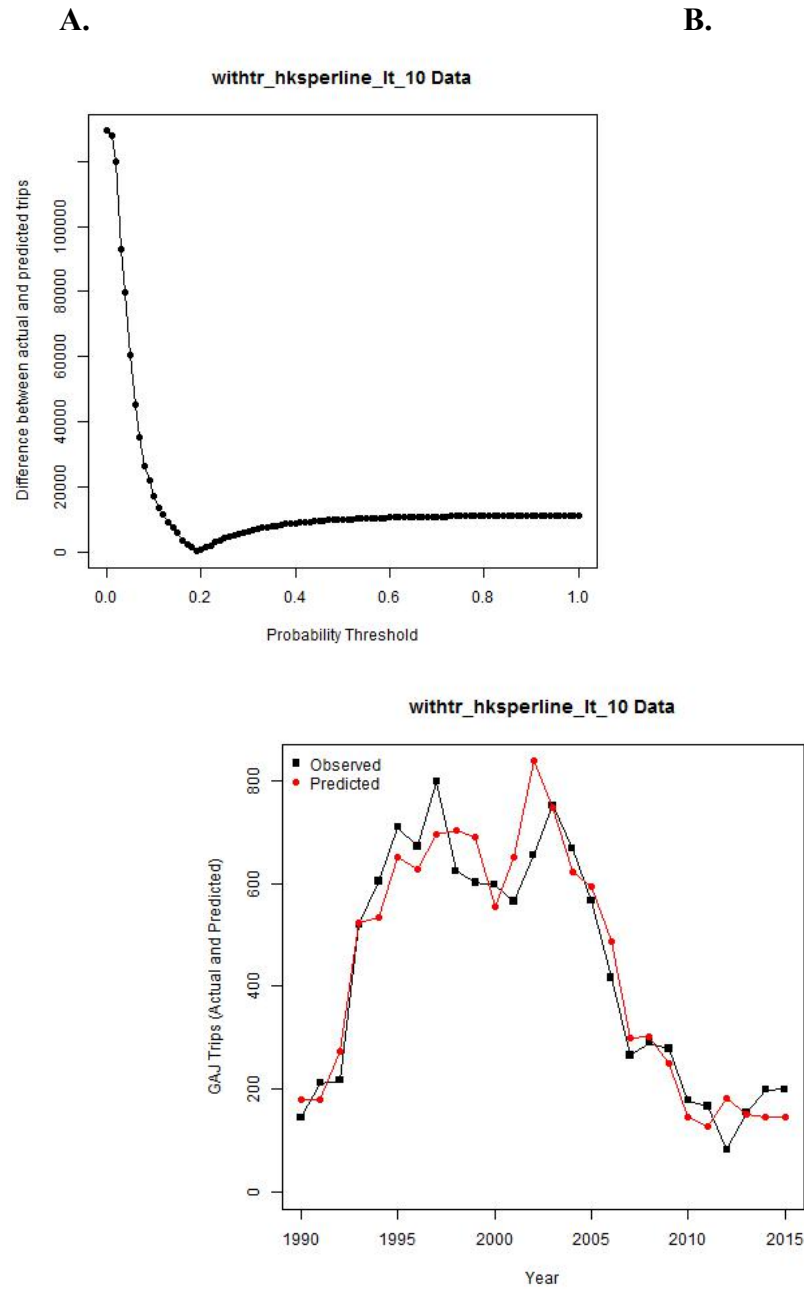
Year	Standardized Index	CV	Lower 95% CI	Upper 95% CI	Nominal CPUE
1990	0.6538	0.3969	0.3042	1.4051	1.1014
1991	0.8939	0.3030	0.4942	1.6169	1.1045
1992	1.6523	0.3241	0.8782	3.1086	2.0476
1993	0.6913	0.2827	0.3970	1.2037	1.0860
1994	0.4187	0.2687	0.2470	0.7100	1.2915
1995	0.6475	0.2765	0.3763	1.1143	1.1184
1996	0.5279	0.2980	0.2946	0.9459	0.3140
1997	0.7246	0.2643	0.4310	1.2184	0.5353
1998	0.7473	0.2717	0.4382	1.2744	3.7559
1999	0.7146	0.2682	0.4218	1.2106	0.7410
2000	0.7337	0.2738	0.4286	1.2563	0.5240
2001	0.8930	0.2678	0.5275	1.5116	0.8016
2002	1.1617	0.2668	0.6876	1.9626	0.7192
2003	1.3573	0.2551	0.8214	2.2428	0.9342
2004	1.5155	0.2667	0.8972	2.5598	1.0218
2005	2.3022	0.2650	1.3673	3.8762	1.4786
2006	1.5475	0.2642	0.9205	2.6015	0.8116
2007	1.2797	0.2774	0.7423	2.2062	1.0532
2008	1.7756	0.2691	1.0464	3.0128	1.2153
2009	2.1607	0.2827	1.2409	3.7620	1.5719
2010	1.6544	0.3803	0.7933	3.4503	0.8363
2011	0.2727	0.4091	0.1242	0.5989	0.1893
2012	0.3460	0.5979	0.1145	1.0455	0.4325
2013	0.5848	0.5449	0.2109	1.6214	0.3830
2014	0.2541	0.4085	0.1158	0.5575	0.3626
2015	0.5102	0.3638	0.2521	1.0326	0.7664

## FIGURES

**Figure 1:** Proportion of positive trips after Stephens and MacCall (2004) trip selection for the handline and longline fisheries.

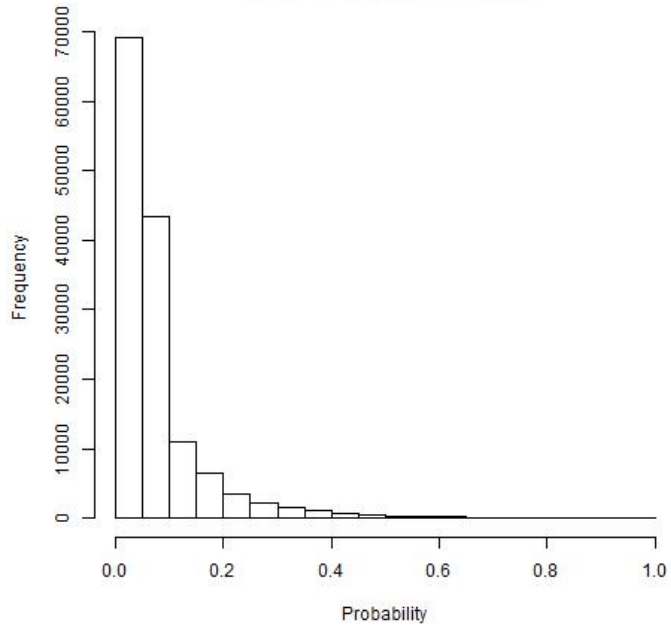


**Figure 2:** Stephens and MacCall (2004) model diagnostics for Greater Amberjack from the handline fishery in the Gulf of Mexico. a) Numbers of predicted and observed trips that caught GAJ over time; b) Difference between the number of trips in which greater amberjack were observed and the number in which they were predicted; and c) Frequency of probabilities generated by the species regression.

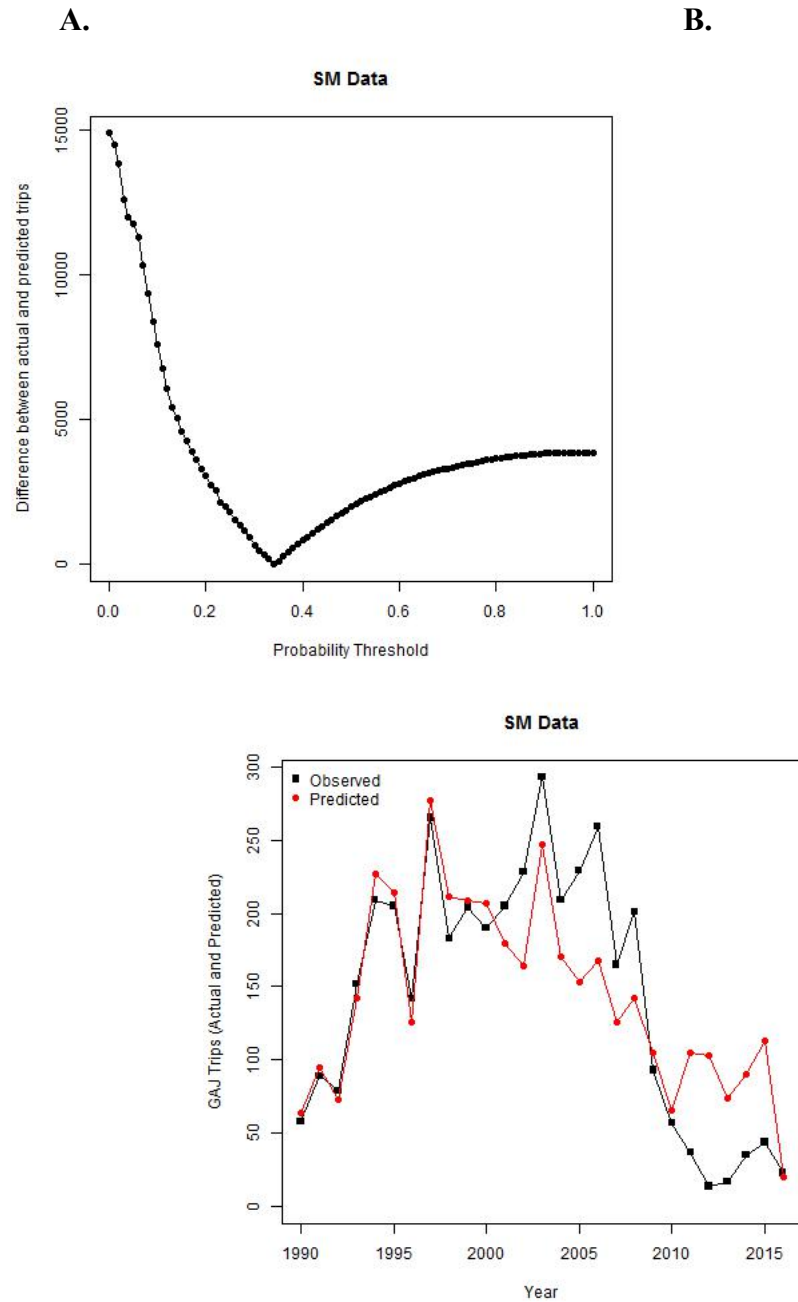


**C.**

withtr\_hksperline\_it\_10 Data

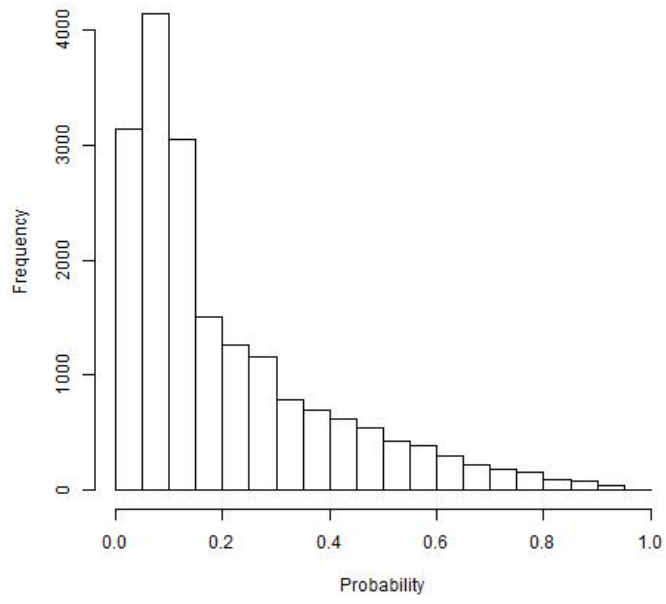


**Figure 3:** Stephens and MacCall (2004) model diagnostics for Greater Amberjack from the longline fishery in the Gulf of Mexico. a) Numbers of predicted and observed trips that caught GAJ over time; b) Difference between the number of trips in which greater amberjack were observed and the number in which they were predicted; and c) Frequency of probabilities generated by the species regression.



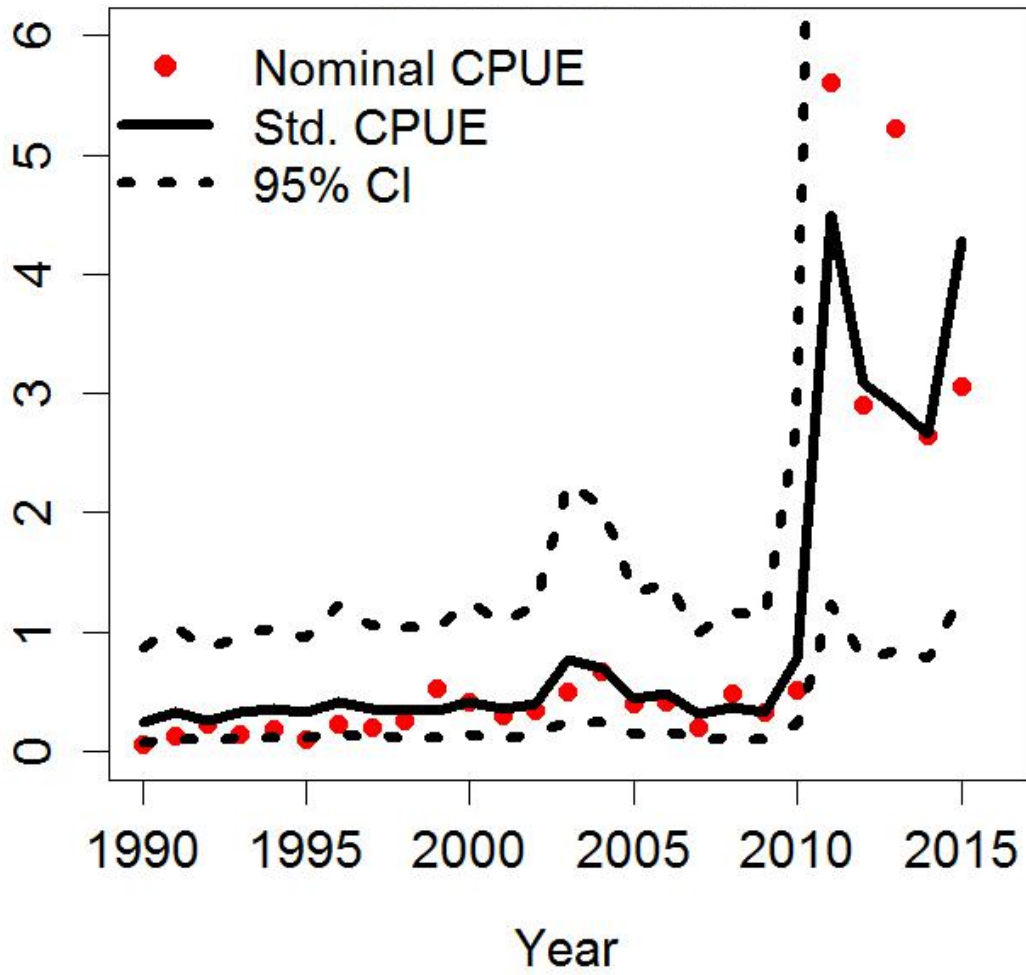
**C.**

**SM Data**

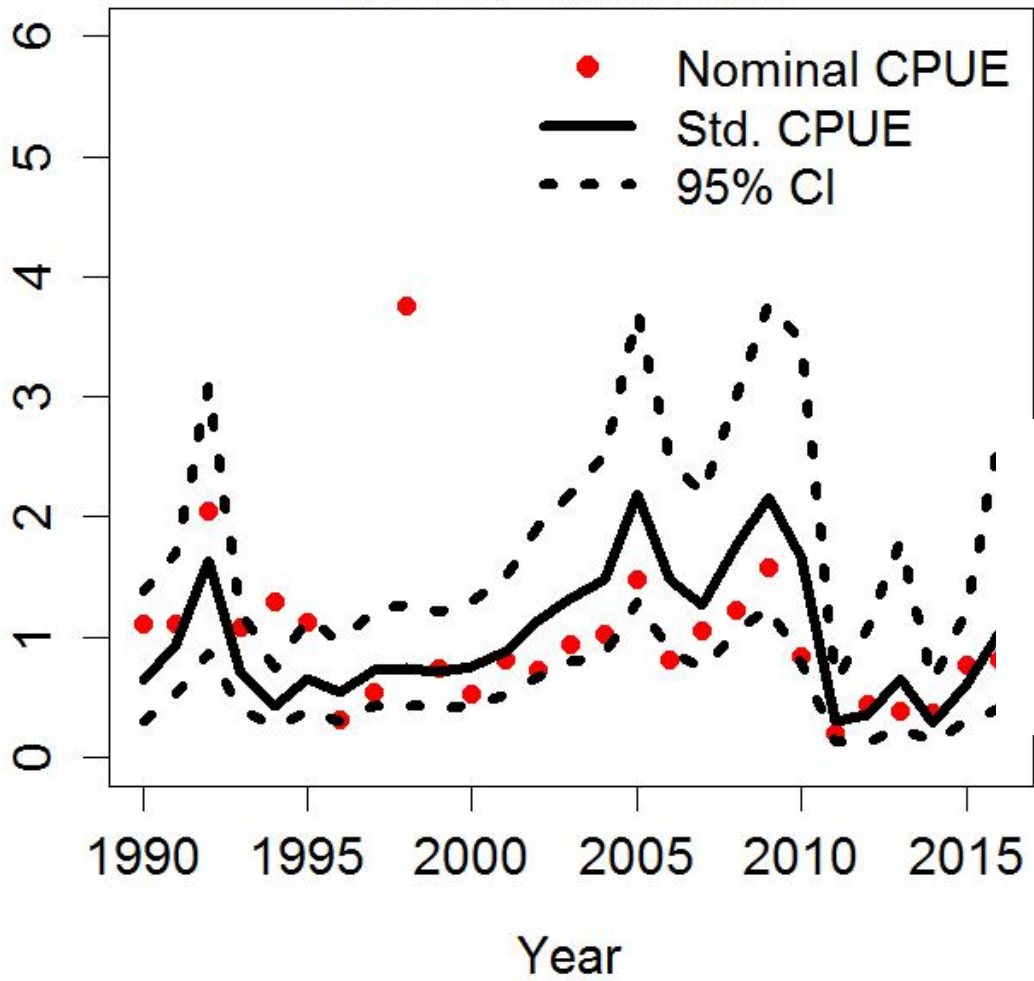




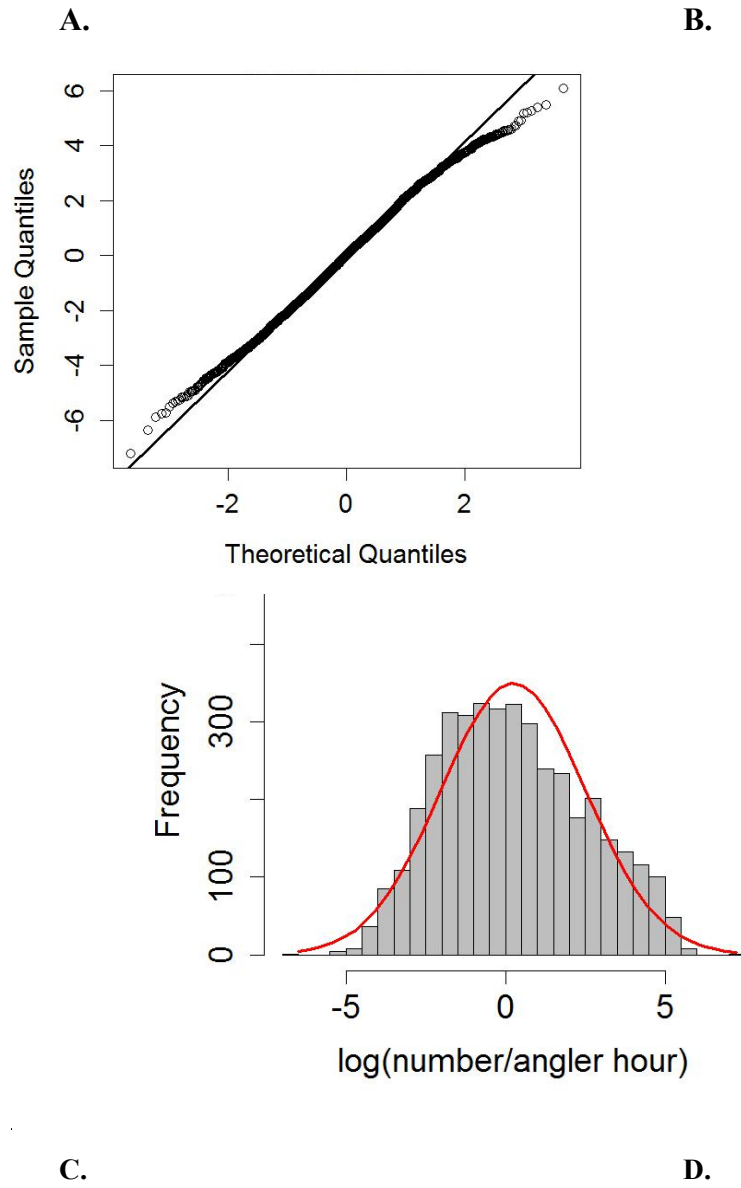
**Figure 4:** Nominal CPUE, final standardized CPUE index, and the 95% confidence intervals for Gulf of Mexico greater amberjack from the commercial handline fishery.

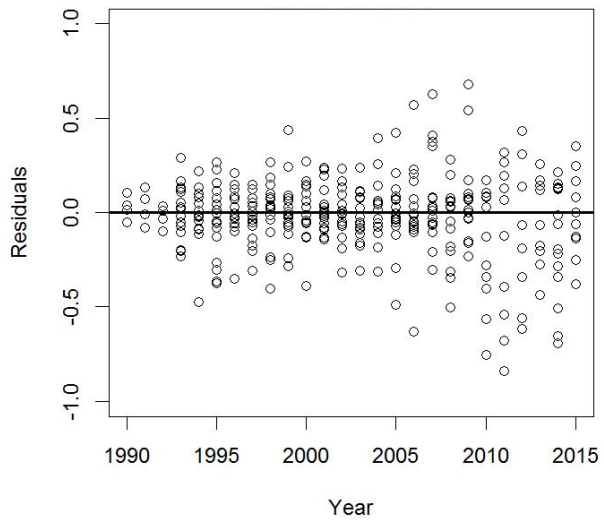
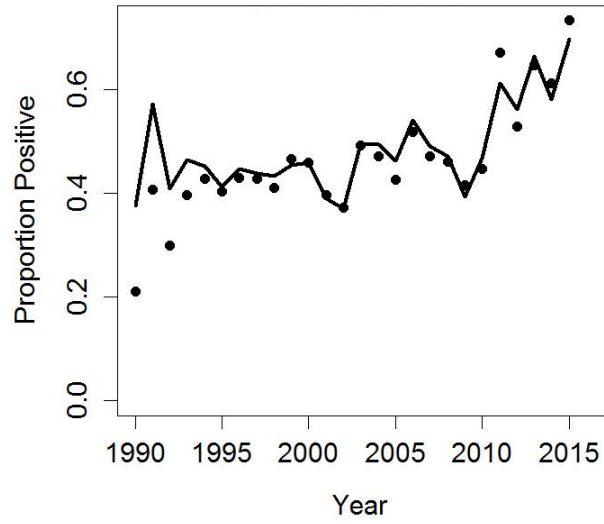


**Figure 5:** Nominal CPUE, final standardized CPUE index, and the 95% confidence intervals for Gulf of Mexico greater amberjack from the commercial longline fishery.

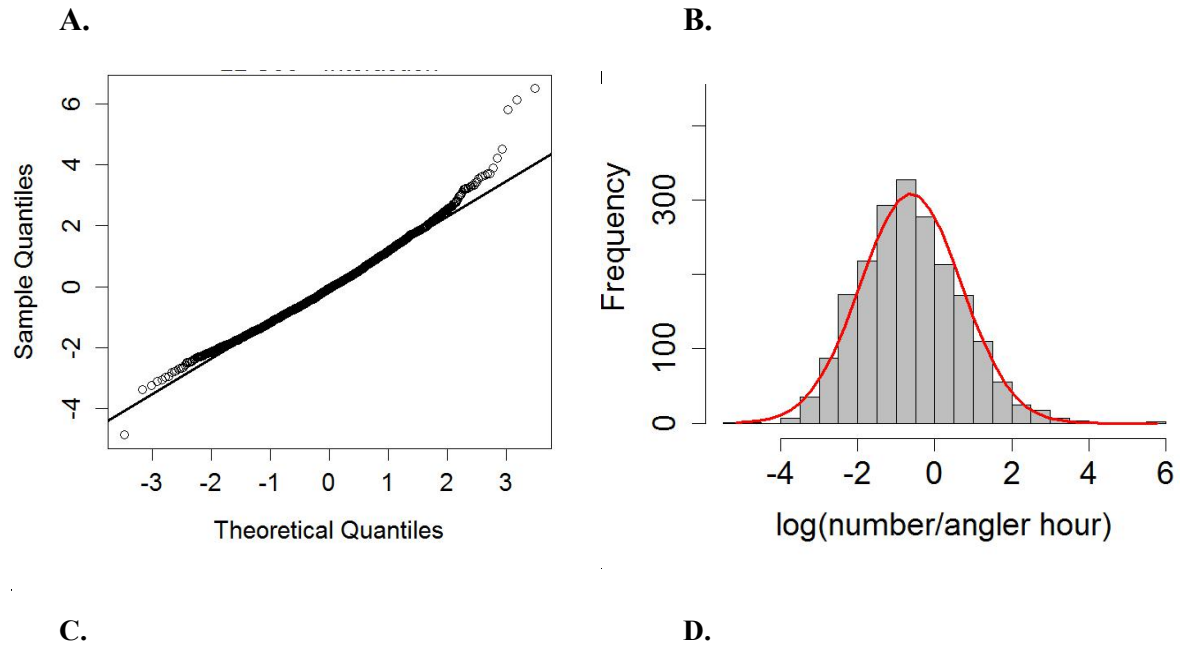


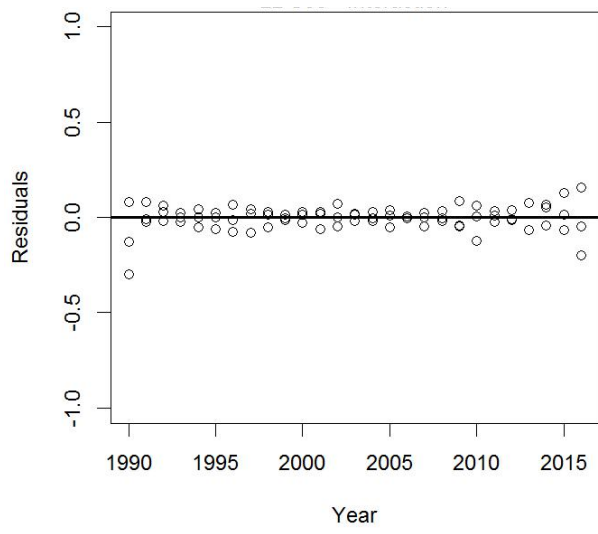
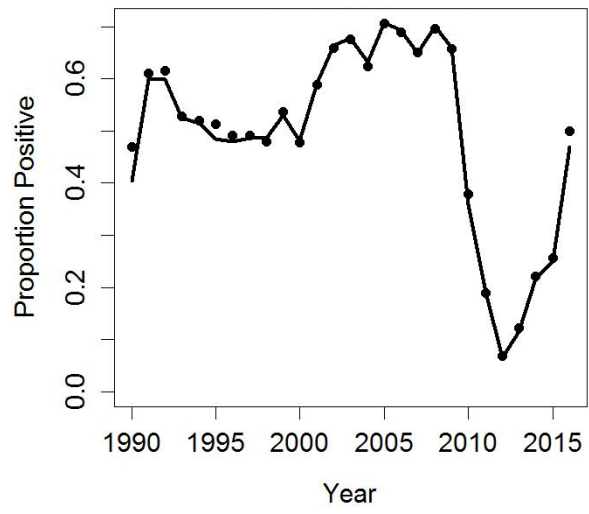
**Figure 6:** Diagnostic plots for the standardized handline index: A) QQ-Plot of CPUE; B) Frequency distribution of catch rates on positive trips (the red line is the expected normal distribution); C) Fit of the binomial proportion positive model to the observed proportion positive values; and D) Plot of the binomial model residuals.



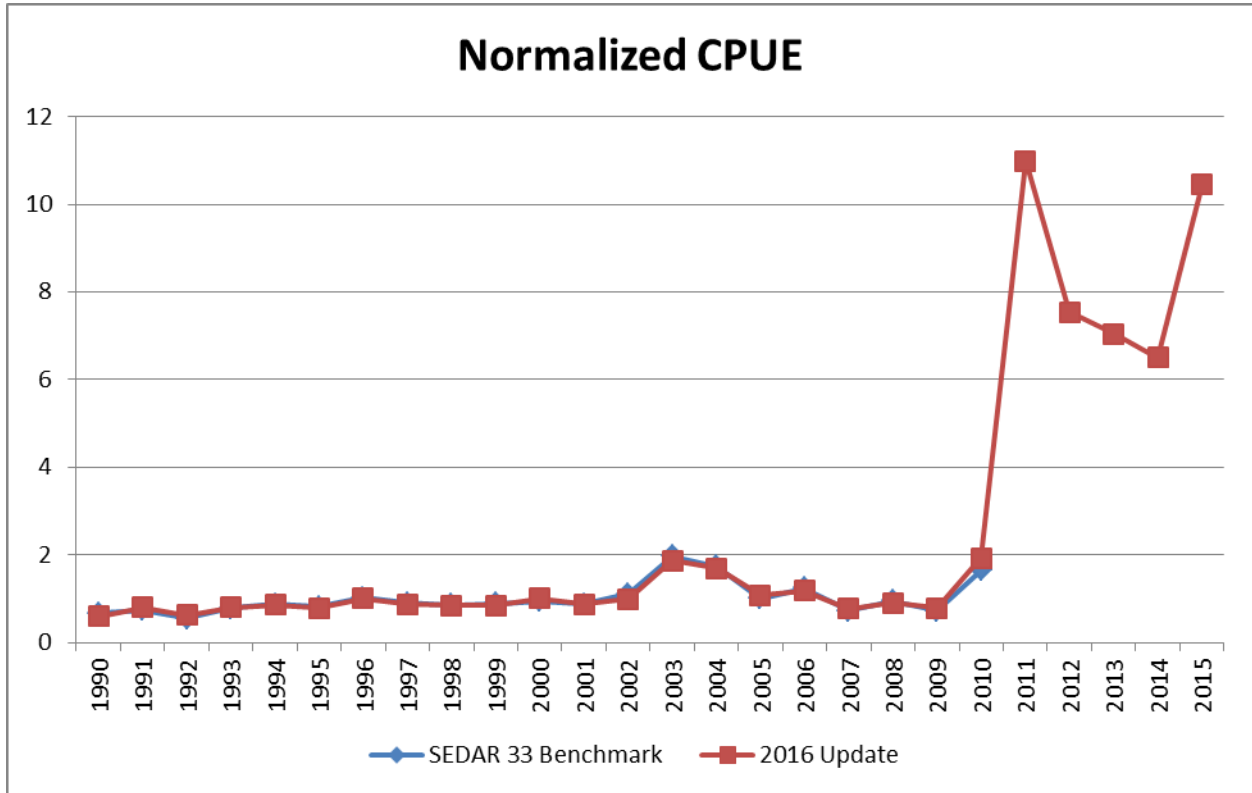


**Figure 7:** Diagnostic plots for the standardized longline index: A) QQ-Plot of CPUE; B) Frequency distribution of catch rates on positive trips (the red line is the expected normal distribution); C) Fit of the binomial proportion positive model to the observed proportion positive values; and D) Plot of the binomial model residuals.

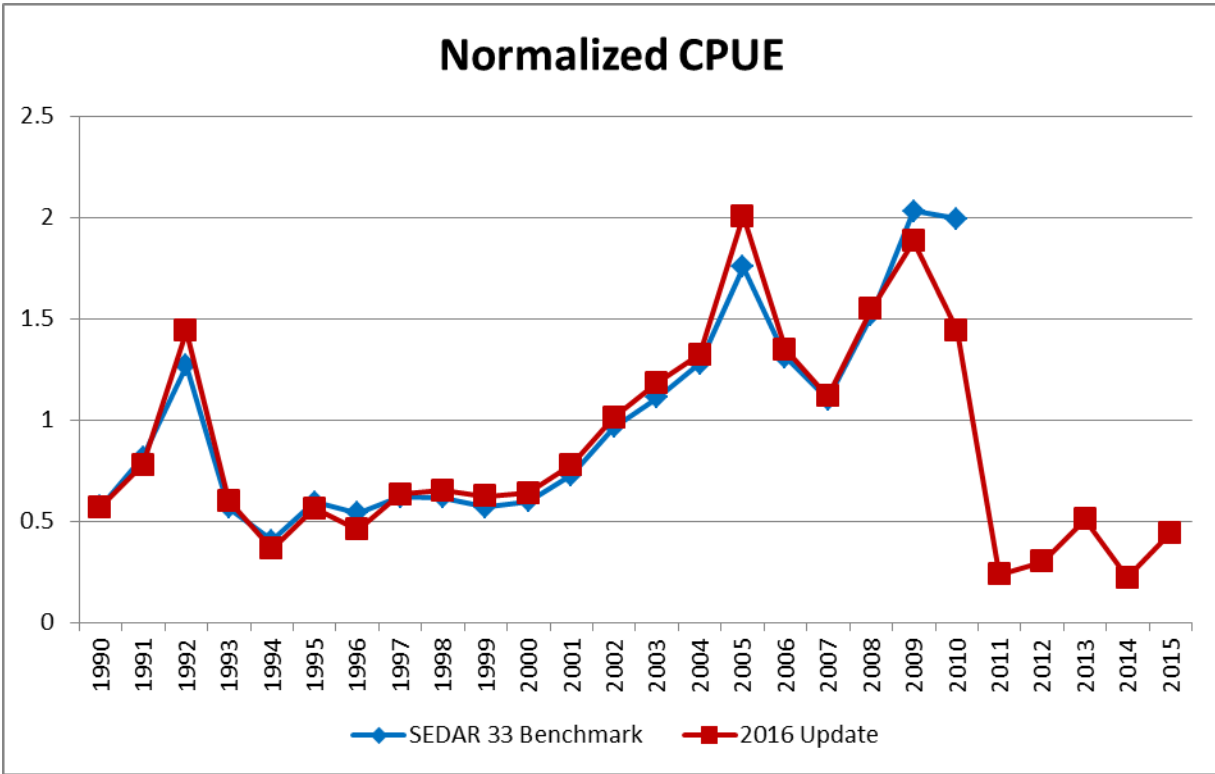




**Figure 8:** Standardized handline index from the 2013 SEDAR 33 Benchmark compared to the standardized handline indices developed for the 2016 Update. Indices were normalized by their respective means from the overlapping time period (1990-2010).

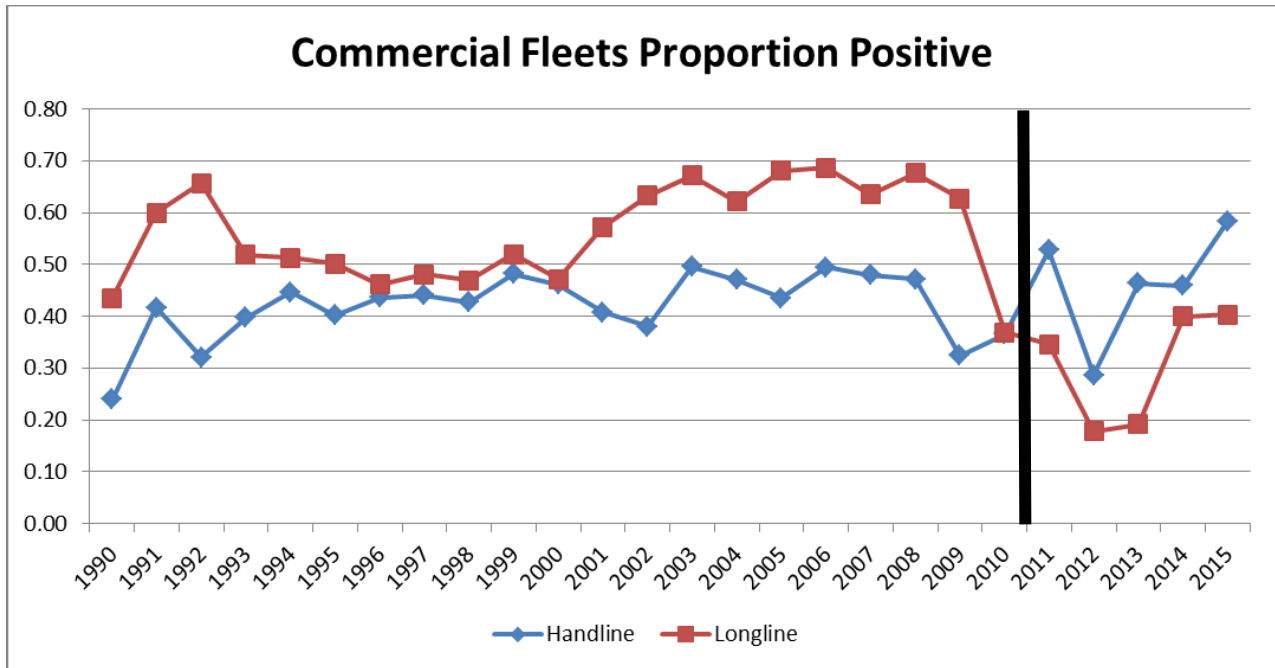


**Figure 9:** Standardized longline index from the 2013 SEDAR 33 Benchmark compared to the standardized longline indices developed for the 2016 Update. Indices were normalized by their respective means from the overlapping time period (1990-2010).



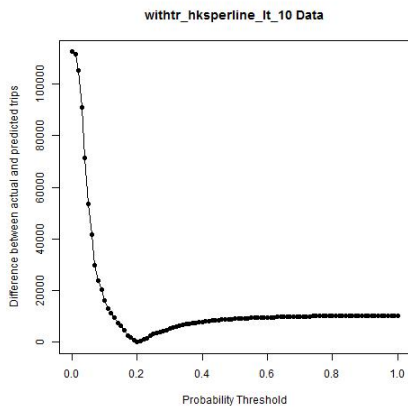


**Figure 10:** Split series proportion of positive trips after Stephens and MacCall (2004) trip selection for the handline and longline fisheries. The vertical line indicates where the timeseries was split and new trip selection analysis was undertaken.

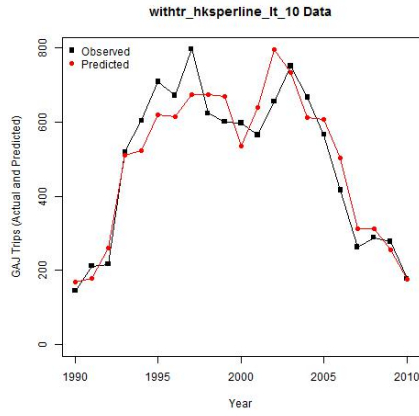


**Figure 11:** Split series Stephens and MacCall (2004) model diagnostics for Greater Amberjack from the handline fishery in the Gulf of Mexico. a) Numbers of predicted and observed trips that caught GAJ over time; b) Difference between the number of trips in which greater amberjack were observed and the number in which they were predicted; and c) Frequency of probabilities generated by the species regression. The top panel is for the 1990-2010 index and the bottom panel is for the 2011-2015 index.

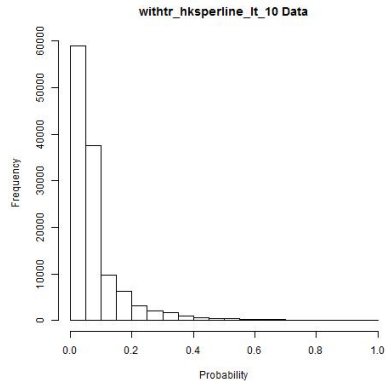
**A.**



**B.**



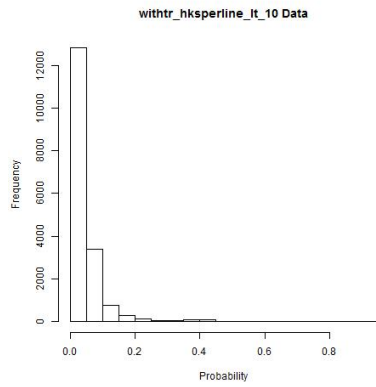
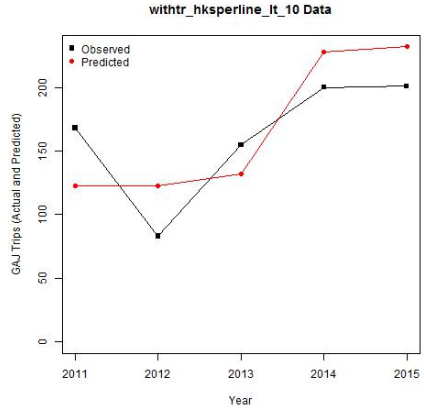
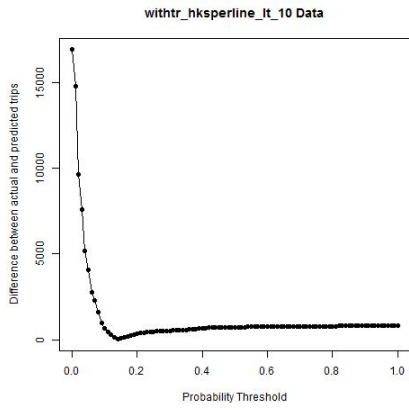
**C.**



**A.**

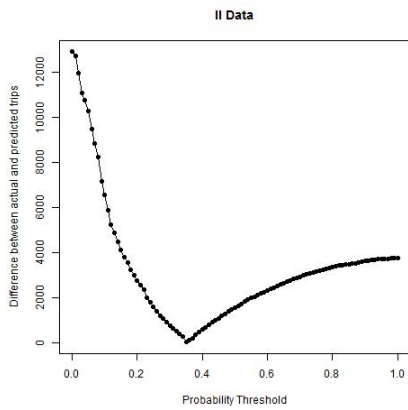
**B.**

**C.**

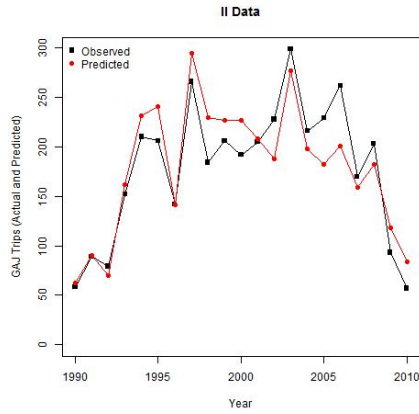


**Figure 12:** Split series Stephens and MacCall (2004) model diagnostics for Greater Amberjack from the longline fishery in the Gulf of Mexico. a) Numbers of predicted and observed trips that caught GAJ over time; b) Difference between the number of trips in which greater amberjack were observed and the number in which they were predicted; and c) Frequency of probabilities generated by the species regression. The top panel is for the 1990-2010 index and the bottom panel is for the 2011-2015 index.

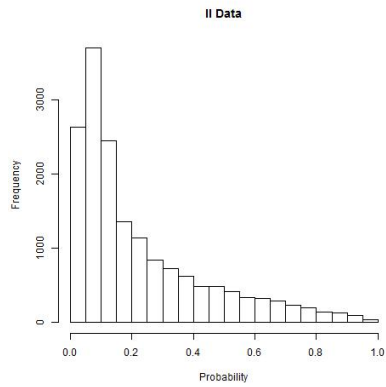
**A.**



**B.**



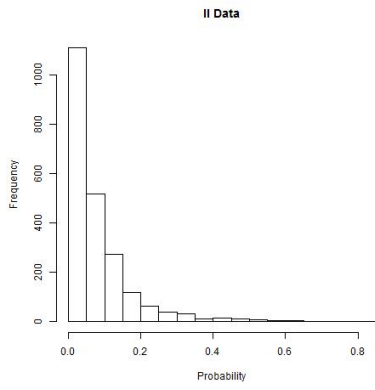
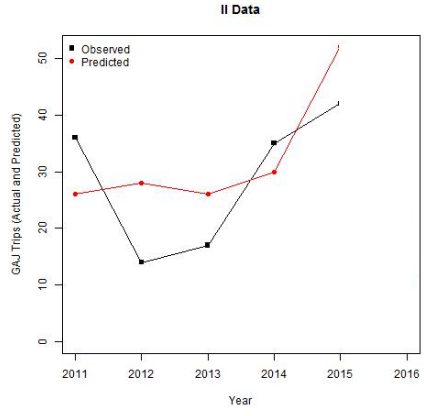
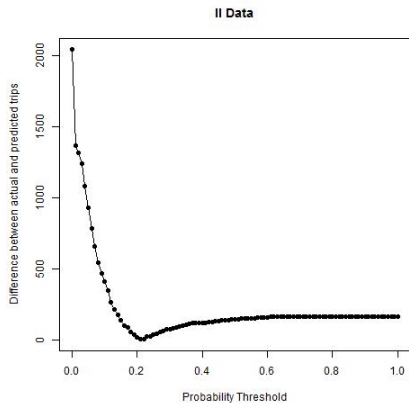
**C.**



**A.**

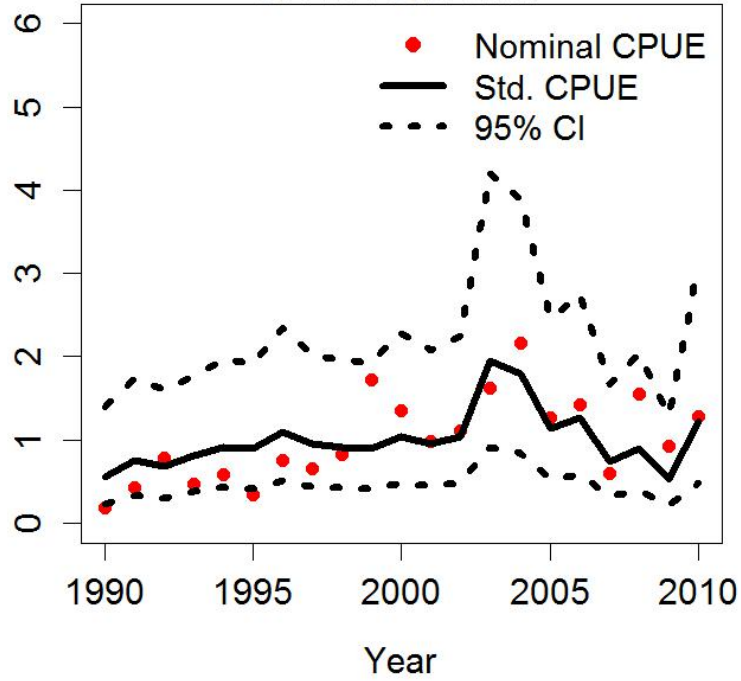
**B.**

**C.**

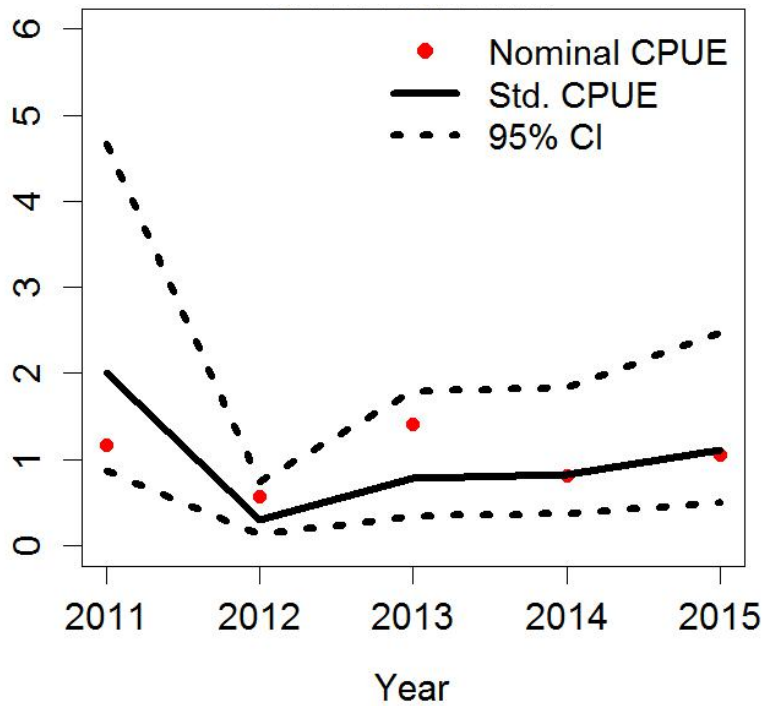


**Figure 13:** Split series nominal CPUE, final standardized CPUE index, and the 95% confidence intervals for Gulf of Mexico greater amberjack from the commercial handline fishery. The top panel (A) is for the 1990-2010 index and the bottom panel (B) is for the 2011-2015 index.

A.

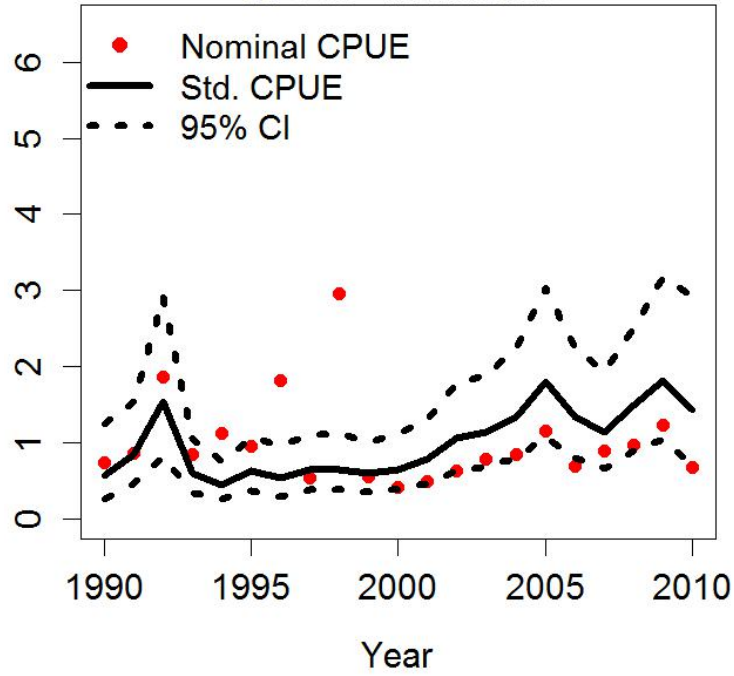


B.

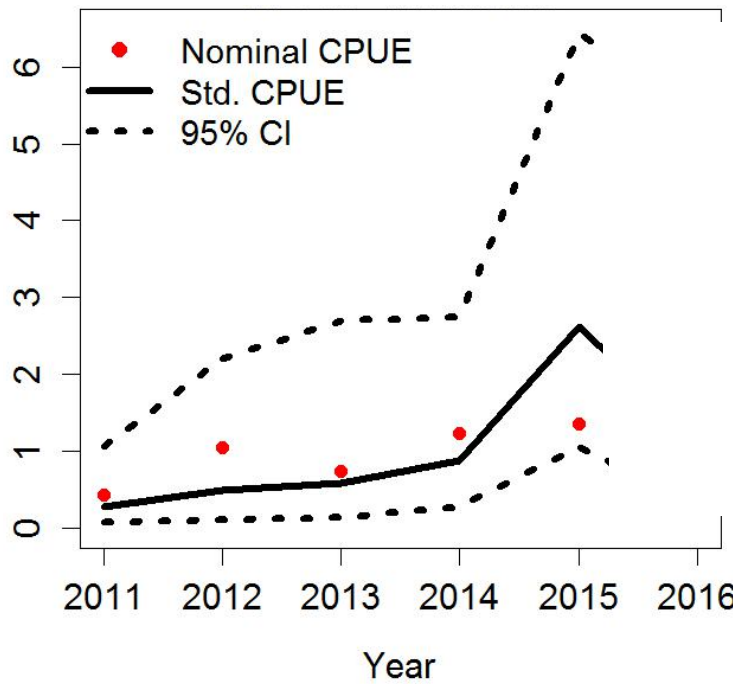


**Figure 14:** Split series nominal CPUE, final standardized CPUE index, and the 95% confidence intervals for Gulf of Mexico greater amberjack from the commercial longline fishery. The top panel (A) is for the 1990-2010 index and the bottom panel (B) is for the 2011-2015 index.

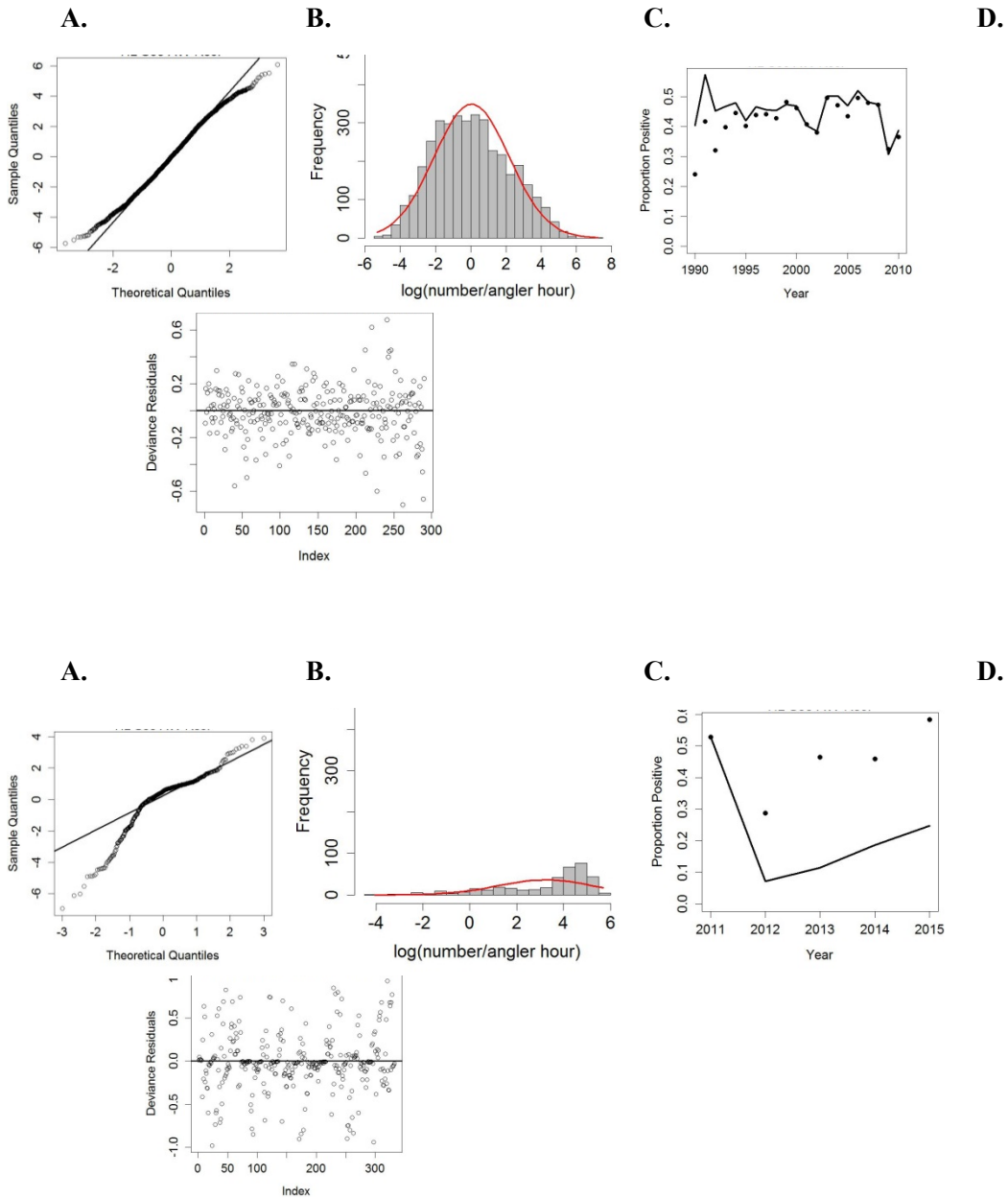
A.



B.

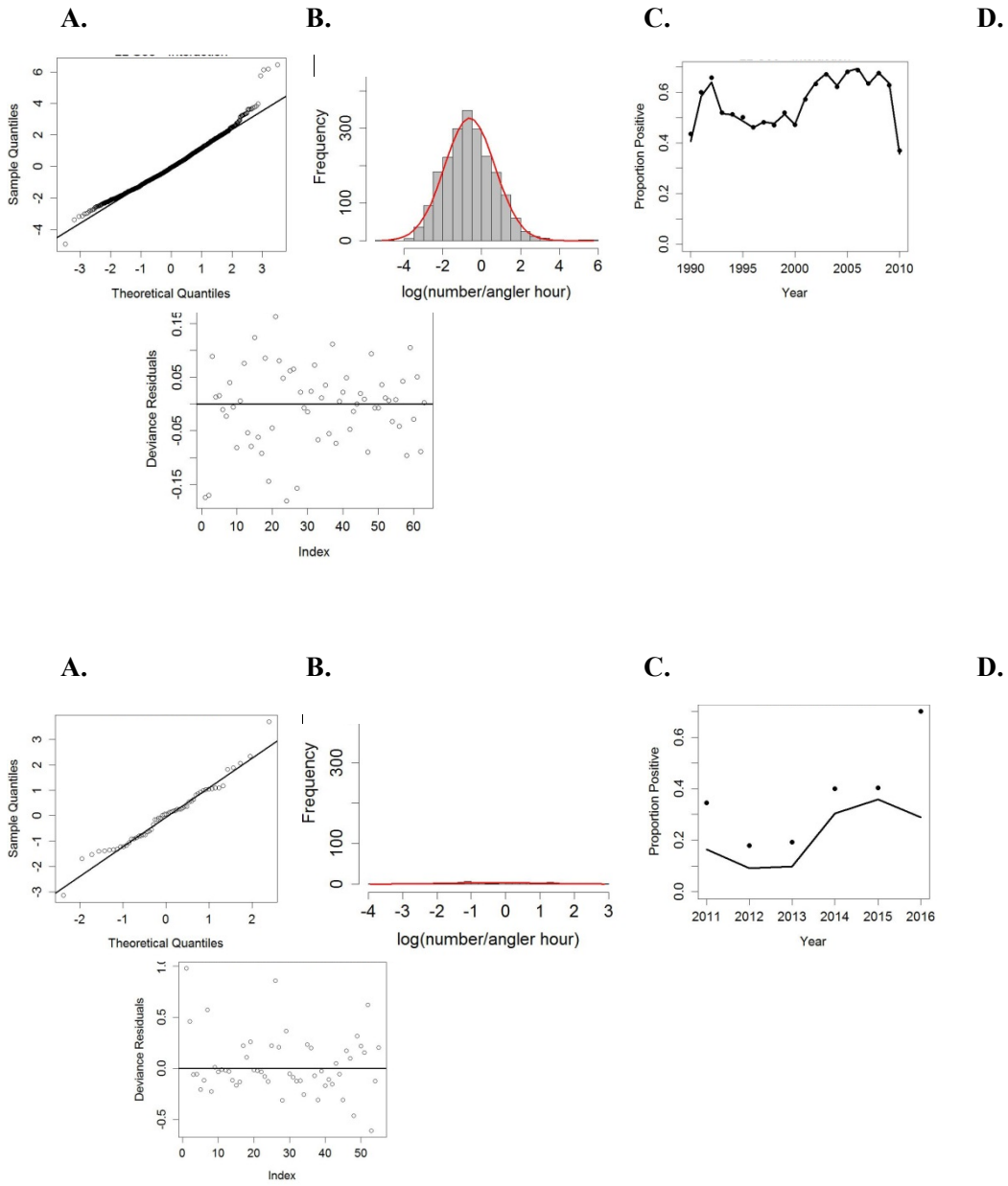


**Figure 15:** Split series diagnostic plots for the standardized handline index: A) QQ-Plot of CPUE; B) Frequency distribution of catch rates on positive trips (the red line is the expected normal distribution); C) Fit of the binomial proportion positive model to the observed proportion positive values; and D) Plot of the binomial model residuals. The top panel is for the 1990-2010 index and the bottom panel is for the 2011-2015 index.

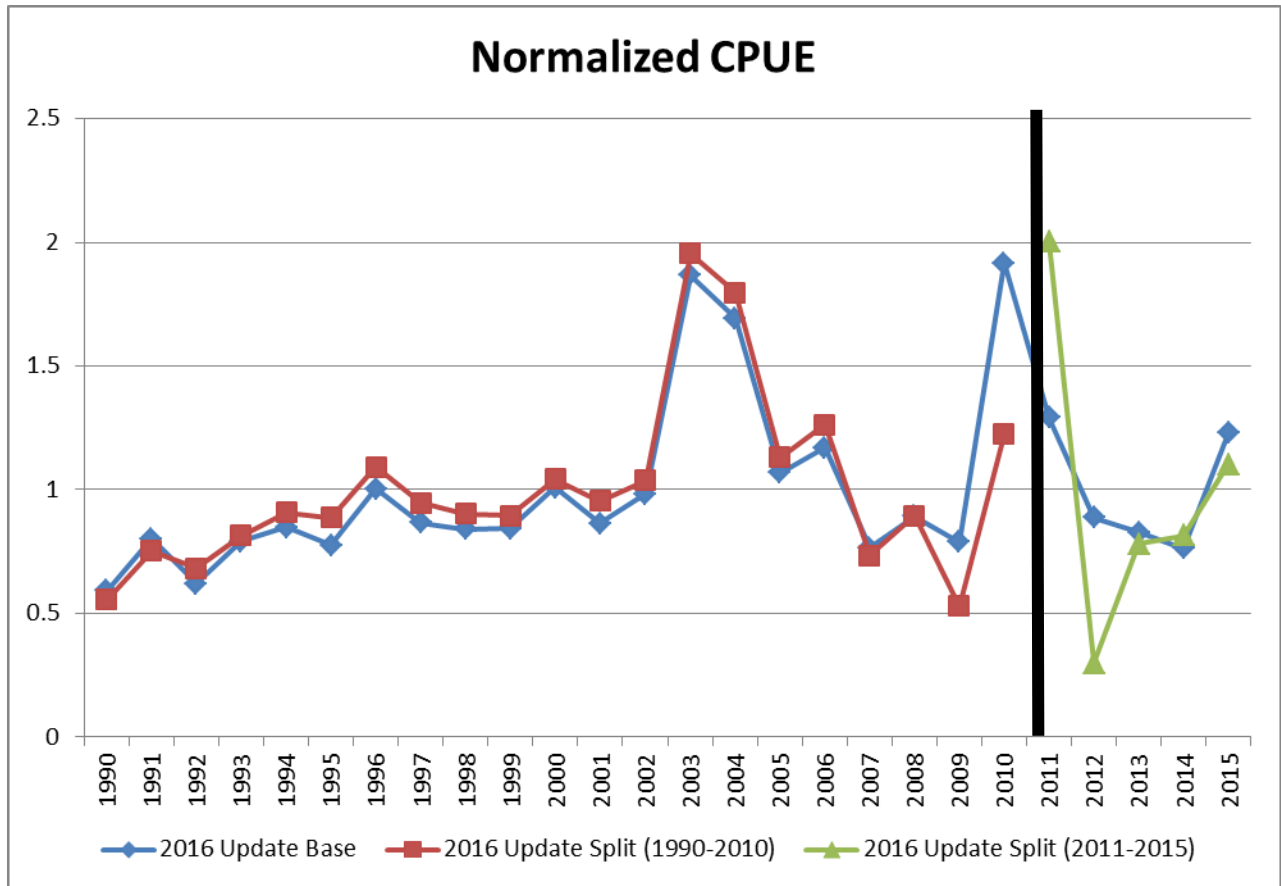




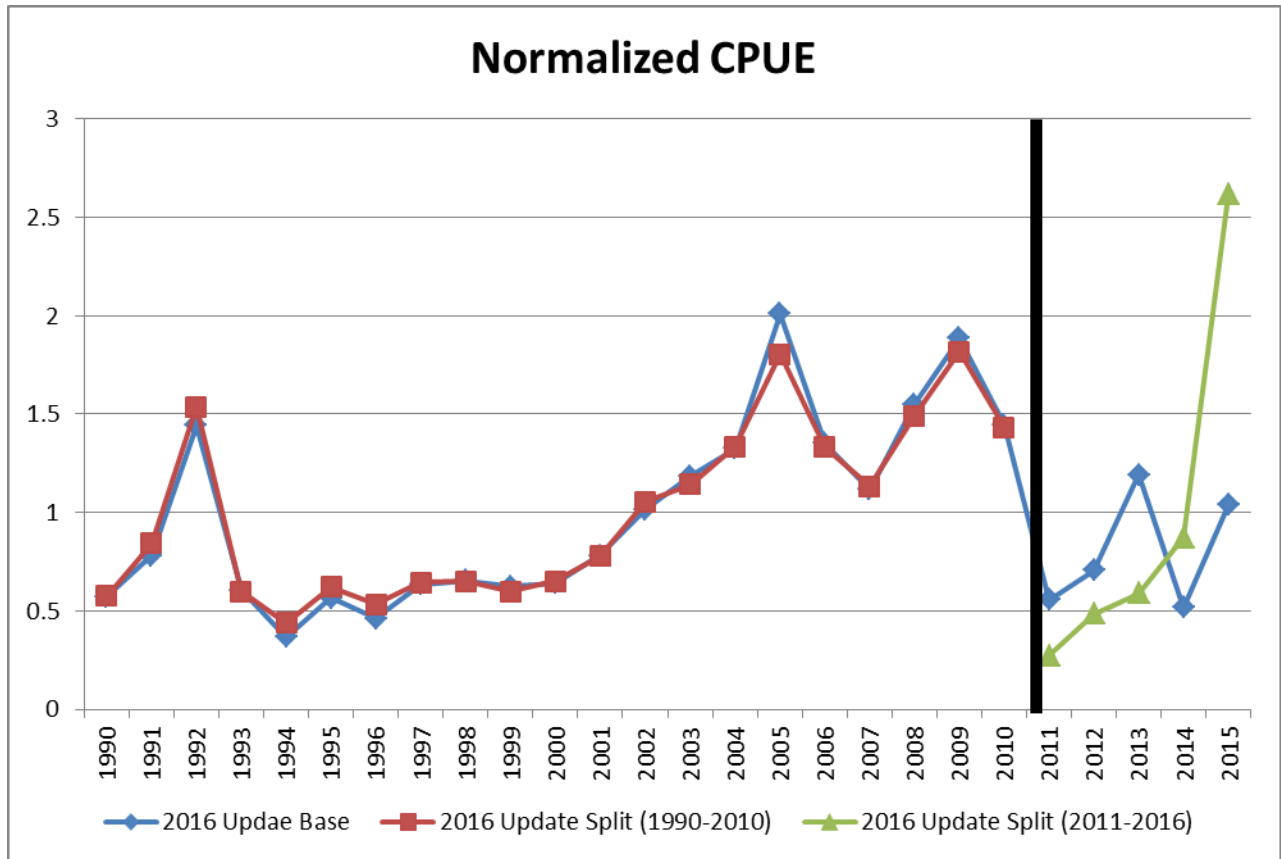
**Figure 16:** Split series diagnostic plots for the standardized longline index: A) QQ-Plot of CPUE; B) Frequency distribution of catch rates on positive trips (the red line is the expected normal distribution); C) Fit of the binomial proportion positive model to the observed proportion positive values; and D) Plot of the binomial model residuals. The top panel is for the 1990-2010 index and the bottom panel is for the 2011-2015 index.



**Figure 17:** Comparison of the 2016 Update base model standardized handline CPUE index to the two split series indices. Indices were normalized by their respective means from the overlapping time period (i.e., 1990-2010 or 2011-2015; black vertical line indicates the two different time periods used for normalizing the indices).



**Figure 18:** Comparison of the 2016 Update base model standardized longline CPUE index to the two split series indices. Indices were normalized by their respective means from the overlapping time period (i.e., 1990-2010 or 2011-2015; black vertical line indicates the two different time periods used for normalizing the indices).



## Appendix C.

Working Document, SEDAR 33 Update

August 15, 2015

### **Standardized Catch Rate Indices for Gulf of Mexico Greater Amberjack (*Seriola dumerili*) Recreational MRFSS and Headboat Fisheries, 1986-2015**

Daniel Goethel and Adyan Rios, NMFS, SEFSC, Miami Laboratory

Standardized catch rate indices (Catch-per-Unit Effort; CPUE) were developed independently for the recreational MRFSS (private and charter) and headboat fisheries across the entire Gulf of Mexico. The methods outlined at the 2013 SEDAR 33 Benchmark (see SEDAR 33-AW20 and SEDAR33-AW21) were used to update each index through the terminal year of the 2016 SEDAR 33 Update (i.e., 2015).

#### **Data**

- The National Marine Fisheries Service (NMFS) Gulf of Mexico (GoM) Marine Recreational Fishery Statistics Survey (MRFSS) data set (1986 – 2015) was utilized to develop a MRFSS-based CPUE index.
- The National Marine Fisheries Service (NMFS) Gulf of Mexico (GoM) Headboat Survey (HBS) data set (1986 – 2015) was utilized to develop a HBS-based CPUE index (referred to as the HBT index).
- Data was filtered to exclude any trips that appeared to be incorrectly reported.
- Due to extensive closed areas in 2010 caused by the Deepwater Horizon/BP Oil Spill, data from 2010 was excluded from the analysis.
- Data from statistical areas 2-21 (Gulf of Mexico excluding the Florida Keys) were used.

#### **Analysis**

- A single abundance index was developed for each data set (MRFSS or HBT) across the entire Gulf of Mexico.
- For the HBT index the Stephens and MacCall (SM; 2004) method was applied to identify and remove trips that were unlikely to have occurred in greater amberjack habitat based on logistic regression of species presence/absence.
- For the MRFSS index a guild-by-mode approach was used as a trip selection criteria where all trips targeting greater amberjack were kept along with those trips where a species was reported that was part of the mode-specific guild (see SEDAR33-AW20 for further details)
- A two-stage delta lognormal model (Lo et al. 1992) was applied to remove the influence of extraneous factors, which consisted of a binomial generalized linear model (GLM) on the proportion of positive trips and a normal GLM on the log of CPUE (fish caught/total hours fished).
- Stepwise variable selection was utilized where factor significance was based on AIC criteria and percent deviance explained (factors were only included if deviance explained > 1%).
- Two-way interaction terms were examined for significant factors where interactions with the year variable were included as random effects.
- The *Year* variable was forced to be in all models.

- The program was implemented using the SAS macro, GLIMMIX (Little et al. 1996).

## Results

- Tables 1 (MRFSS) and 2 (HBT) provide the total trips after logbook filtering and SM or guild-by-mode trip selection, while Figure 1 illustrates the yearly proportion of positive trips and Figure 2 gives the SM model diagnostics for the HBT index.
- The final binomial models were:
  - MRFSS:  $Proportion\ Positive = Year + Region + Mode + Area + Hours\ Fished + Year*Region + Year*Hours\ Fished$
  - HBT:  $Proportion\ Positive = Year + Region$
  - The chosen factors were consistent with the 2013 Benchmark models, but the  $Year*Region$  interaction term was dropped from the HBT index due to convergence issues.
- The final normal models were:
  - MRFSS:  $ln(CPUE) = Year + Region + Mode$
  - HBT:  $ln(CPUE) = Year + Region + Season + Year*Region$
  - Differences from the final 2013 models included the inclusion of *Mode* as a significant factor for the 2016 Update MRFSS model and the lack of *Wave* as a significant factor; while the HBT index included *Season* as a significant factor (all other chosen factors were consistent with the 2013 Benchmark models).
- Tables 3 (MRFSS) and 4 (HBT) provide the final CPUE indices including CVs and nominal CPUE, while final indices are also provided in Figures 3-4.
- Final model diagnostics are provided in Figures 5-6.
- Figures 7-8 provide a comparison to the final 2013 Benchmark indices where each index was normalized to its mean over a common time period (1986-2010).

## Discussion

The final base recreational CPUE indices for both the MRFSS and headboat data sets exhibited strong consistency in trends over the entire time series (Figure 9). Both started with noisy but declining trends in the historical part of the time series before stabilizing with no trend through much of the 1990s. Increases occurred in the early-2000s followed by slight declines around 2004. Both indices have been fluctuating without any strong trend for a majority of the last decade. The headboat index showed strong model diagnostics. The MRFSS index demonstrated poor fit to the binomial component (similar to the SEDAR 33 Benchmark model), but the fit to the  $ln(CPUE)$  component was good. Both indices replicated the SEDAR 33 Benchmark final CPUE models remarkably well (Figures 7-8).

## LITERATURE CITED

- Littell, R.C., G.A. Milliken, W.W. Stroup, and R.D Wolfinger. 1996. SAS® System for Mixed Models, Cary NC, USA:SAS Institute Inc., 1996. 663 pp.
- Lo, N.C., Jacobson, L.D., and Squire, J.L. 1992. Indices of relative abundance from fish spotter data based on delta-lognormal models. *Can. J. Fish. Aquat. Sci.* 49: 2515-2526.
- Stephens, A., and MacCall, A. 2004. A multispecies approach to subsetting logbook data for purposes of estimating CPUE. *Fish. Res.* 70: 299-310.

## TABLES

**Table 1:** Total trips, positive trips, and proportion of positive trips before (Total) and after trip selection (Guild-by-Mode) for greater amberjack from the MRFSS data. The proportion of trips retained is also provided. Data from 2010 was not used in the analysis.

Year	Total			Guild-by-Mode			
	Positive	Total	Proportion Positive	Positive	Total	Proportion Positive	Proportion of Trips Retained
1986	207	5791	0.04	207	739	0.28	0.13
1987	190	6044	0.03	190	902	0.21	0.15
1988	109	4976	0.02	109	668	0.16	0.13
1989	120	3200	0.04	120	592	0.20	0.19
1990	32	2796	0.01	32	461	0.07	0.16
1991	117	2789	0.04	117	613	0.19	0.22
1992	234	5322	0.04	234	1228	0.19	0.23
1993	117	3880	0.03	117	903	0.13	0.23
1994	89	4522	0.02	89	1134	0.08	0.25
1995	43	4117	0.01	43	845	0.05	0.21
1996	65	4955	0.01	65	936	0.07	0.19
1997	65	5579	0.01	65	1181	0.06	0.21
1998	106	6063	0.02	106	1695	0.06	0.28
1999	216	8980	0.02	216	2555	0.08	0.28
2000	321	7921	0.04	321	2552	0.13	0.32
2001	309	7863	0.04	309	2251	0.14	0.29
2002	507	8415	0.06	507	2568	0.20	0.31
2003	484	7732	0.06	484	2576	0.19	0.33
2004	414	8749	0.05	414	3157	0.13	0.36
2005	260	7434	0.03	260	2306	0.11	0.31
2006	248	7794	0.03	248	1987	0.12	0.25
2007	227	7050	0.03	227	2033	0.11	0.29
2008	245	6612	0.04	245	2072	0.12	0.31
2009	225	5951	0.04	225	1880	0.12	0.32
2011	331	5935	0.06	331	1844	0.18	0.31
2012	348	5424	0.06	348	1937	0.18	0.36
2013	183	4282	0.04	183	1457	0.13	0.34
2014	270	5854	0.05	270	2169	0.12	0.37
2015	337	6165	0.05	337	2013	0.17	0.33

**Table 2:** Total trips, positive trips, and proportion of positive trips before (Total) and after trip selection (Stephens and MacCall) for greater amberjack from the headboat fishery. The proportion of trips retained is also provided. Data from 2010 was not used in the analysis.

Year	Total			Stephens and MacCall			
	Positive	Total	Proportion Positive	Positive	Total	Proportion Positive	Proportion of Trips Retained
1986	1012	2248	0.45	375	517	0.73	0.23
1987	961	2666	0.36	306	529	0.58	0.20
1988	821	2829	0.29	321	523	0.61	0.18
1989	863	2468	0.35	261	436	0.60	0.18
1990	418	3178	0.13	182	499	0.36	0.16
1991	444	2882	0.15	210	566	0.37	0.20
1992	764	3265	0.23	318	662	0.48	0.20
1993	699	3398	0.21	302	772	0.39	0.23
1994	659	4011	0.16	259	811	0.32	0.20
1995	640	3071	0.21	268	707	0.38	0.23
1996	579	3229	0.18	283	703	0.40	0.22
1997	333	2036	0.16	184	482	0.38	0.24
1998	347	2535	0.14	170	599	0.28	0.24
1999	218	1752	0.12	128	381	0.34	0.22
2000	363	2438	0.15	146	475	0.31	0.19
2001	410	2104	0.19	207	467	0.44	0.22
2002	461	1765	0.26	194	422	0.46	0.24
2003	470	1548	0.30	204	380	0.54	0.25
2004	441	1803	0.24	210	374	0.56	0.21
2005	310	1943	0.16	167	457	0.37	0.24
2006	324	1790	0.18	156	424	0.37	0.24
2007	296	1709	0.17	156	504	0.31	0.29
2008	248	993	0.25	99	204	0.49	0.21
2009	324	1104	0.29	163	309	0.53	0.28
2011	160	507	0.32	89	174	0.51	0.34
2012	200	694	0.29	91	186	0.49	0.27
2013	237	2230	0.11	93	217	0.43	0.10
2014	130	1370	0.09	57	141	0.40	0.10
2015	240	1702	0.14	122	260	0.47	0.15

**Table 3:** Gulf of Mexico greater amberjack standardized MRFSS CPUE index values, coefficients of variation, 95% confidence limits, and nominal CPUE values. Data from 2010 was not used in the analysis.

Year	Standardized Index	CV	Lower 95% CI	Upper 95% CI	Nominal CPUE
1986	3.2970	0.2920	1.8607	5.8420	4.5459
1987	2.3925	0.3163	1.2901	4.4368	2.4024
1988	0.7733	0.3751	0.3743	1.5976	1.6935
1989	1.8154	0.3599	0.9033	3.6483	1.8618
1990	0.1967	0.5152	0.0745	0.5192	0.3900
1991	1.9518	0.3428	1.0021	3.8015	2.2080
1992	1.8337	0.2917	1.0353	3.2475	1.6475
1993	0.6560	0.3665	0.3225	1.3343	1.0147
1994	0.5637	0.3788	0.2710	1.1723	0.4746
1995	0.4982	0.4272	0.2197	1.1299	0.4072
1996	0.3548	0.4140	0.1602	0.7860	0.2978
1997	0.3901	0.3958	0.1819	0.8365	0.3231
1998	0.2374	0.3690	0.1162	0.4852	0.2664
1999	0.2371	0.3469	0.1208	0.4654	0.3225
2000	0.5410	0.3423	0.2780	1.0527	0.5446
2001	1.2443	0.3032	0.6876	2.2517	0.9624
2002	1.2906	0.2842	0.7391	2.2537	1.2308
2003	1.2159	0.2850	0.6953	2.1263	1.1117
2004	0.7867	0.2973	0.4396	1.4079	0.5321
2005	0.7984	0.3169	0.4301	1.4822	0.5573
2006	0.6312	0.3408	0.3252	1.2249	0.5939
2007	0.8118	0.3291	0.4275	1.5416	0.5542
2008	0.6880	0.3239	0.3658	1.2940	0.5391
2009	0.9180	0.3216	0.4901	1.7194	0.5311
2011	1.3154	0.3272	0.6951	2.4894	0.9455
2012	0.9165	0.3318	0.4802	1.7494	0.8613
2013	0.9262	0.3321	0.4850	1.7686	0.6590

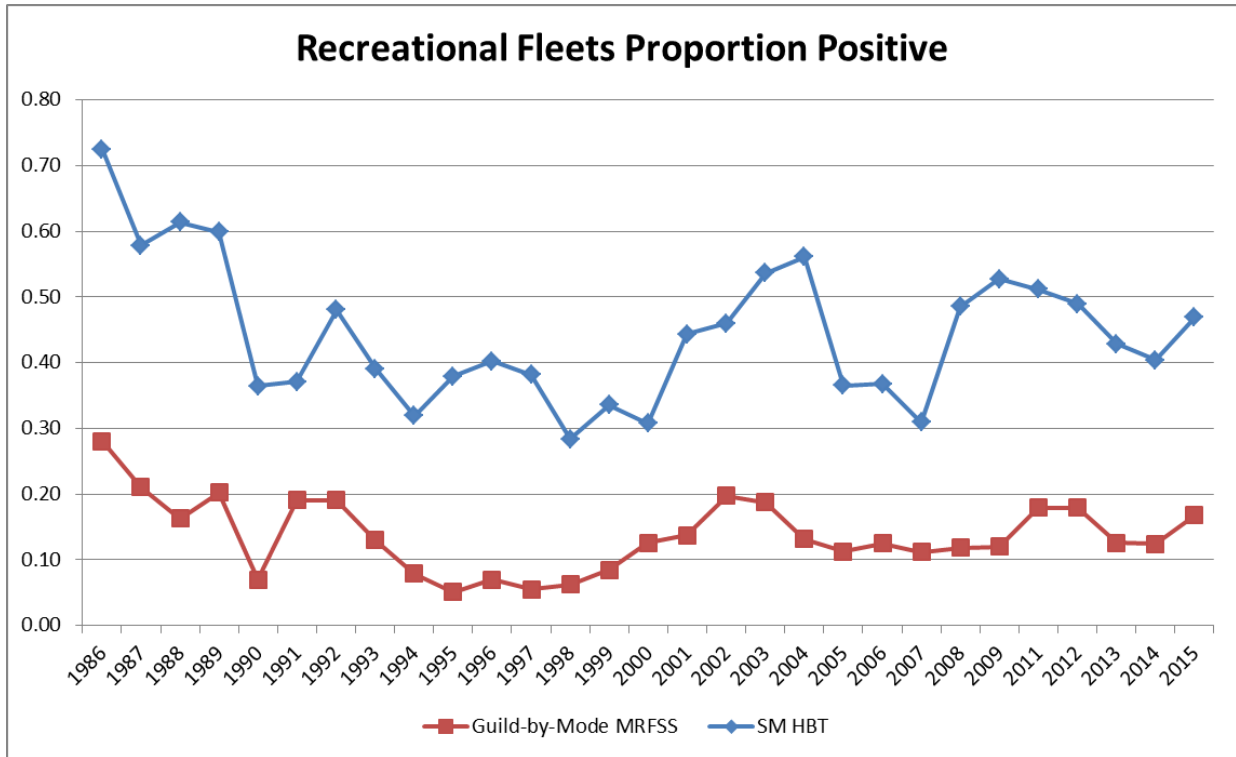


**Table 4:** Gulf of Mexico greater amberjack standardized Headboat CPUE index values, coefficients of variation, 95% confidence limits, and nominal CPUE values. Data from 2010 was not used in the analysis.

Year	Standardized Index	CV	Lower 95% CI	Upper 95% CI	Nominal CPUE
1986	3.7675	0.3307	1.9780	7.1761	3.6250
1987	1.8992	0.3626	0.9405	3.8354	1.8994
1988	2.0192	0.3516	1.0200	3.9970	2.3894
1989	1.5278	0.3653	0.7527	3.1011	1.5238
1990	0.6307	0.4334	0.2751	1.4461	0.8047
1991	0.7423	0.4122	0.3361	1.6394	0.8132
1992	1.2648	0.3672	0.6210	2.5762	1.3701
1993	0.7618	0.3814	0.3646	1.5920	0.6622
1994	0.6048	0.4009	0.2794	1.3090	0.4891
1995	0.7132	0.3946	0.3333	1.5261	0.5623
1996	0.8194	0.3856	0.3892	1.7254	0.8018
1997	0.6298	0.4228	0.2799	1.4173	0.5543
1998	0.4306	0.4455	0.1839	1.0086	0.3368
1999	0.5662	0.4716	0.2311	1.3875	0.5959
2000	0.5644	0.4602	0.2349	1.3561	0.4190
2001	0.9521	0.4065	0.4355	2.0814	0.9083
2002	1.0905	0.4204	0.4866	2.4435	1.0303
2003	1.4760	0.3963	0.6876	3.1682	1.2720
2004	1.1342	0.3932	0.5313	2.4215	0.9548
2005	0.5215	0.4494	0.2212	1.2296	0.4172
2006	0.7164	0.4552	0.3007	1.7063	0.5688
2007	0.4305	0.4644	0.1779	1.0417	0.4407
2008	1.4642	0.4743	0.5948	3.6046	1.7638
2009	0.7697	0.4182	0.3448	1.7182	1.0441
2011	0.8962	0.5147	0.3399	2.3631	0.9216
2012	0.7883	0.5130	0.2998	2.0726	0.9027
2013	0.7163	0.5089	0.2743	1.8704	0.6736
2014	0.4915	0.5942	0.1636	1.4762	0.5401

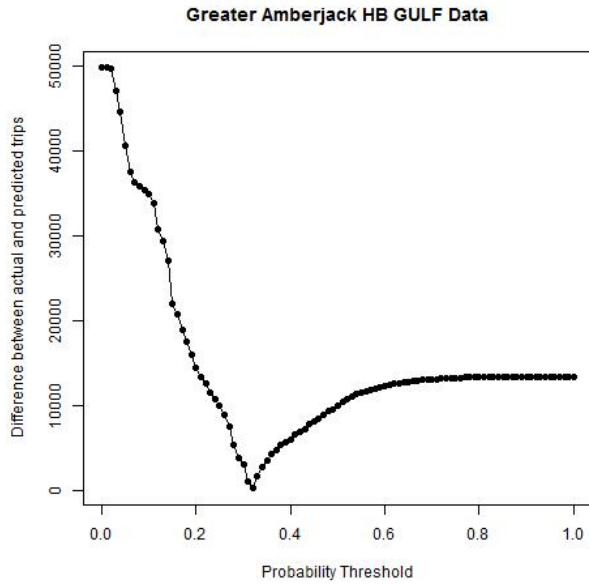
## FIGURES

**Figure 1:** Proportion of positive trips after Guild-by-Mode (MRFSS) or Stephens and MacCall (HBT; 2004) trip selection.

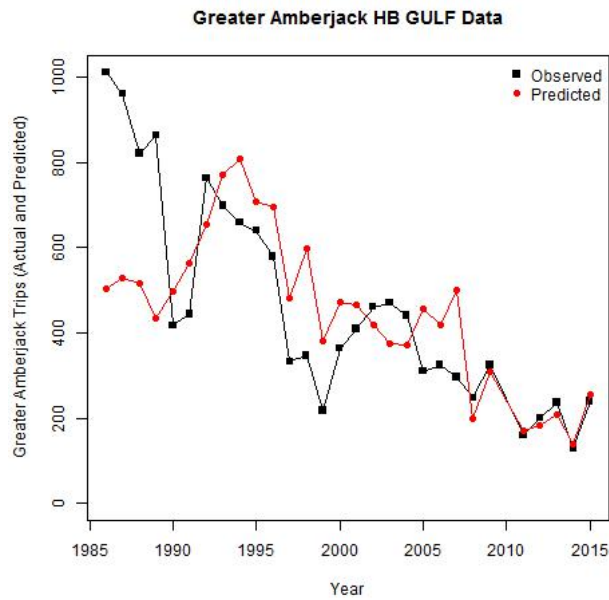


**Figure 2:** Stephens and MacCall (2004) model diagnostics for Greater Amberjack from the headboat fishery in the Gulf of Mexico. a) Numbers of predicted and observed trips that caught GAJ over time; b) Difference between the number of trips in which greater amberjack were observed and the number in which they were predicted; and c) Frequency of probabilities generated by the species regression.

**B.**

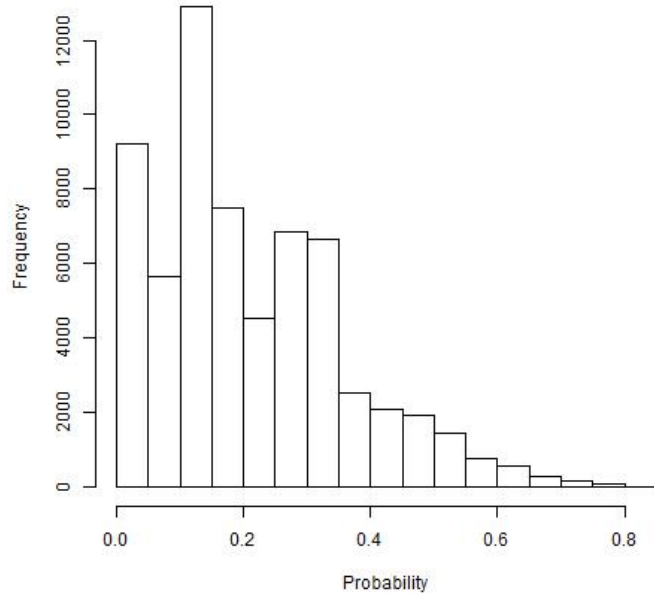


**B.**

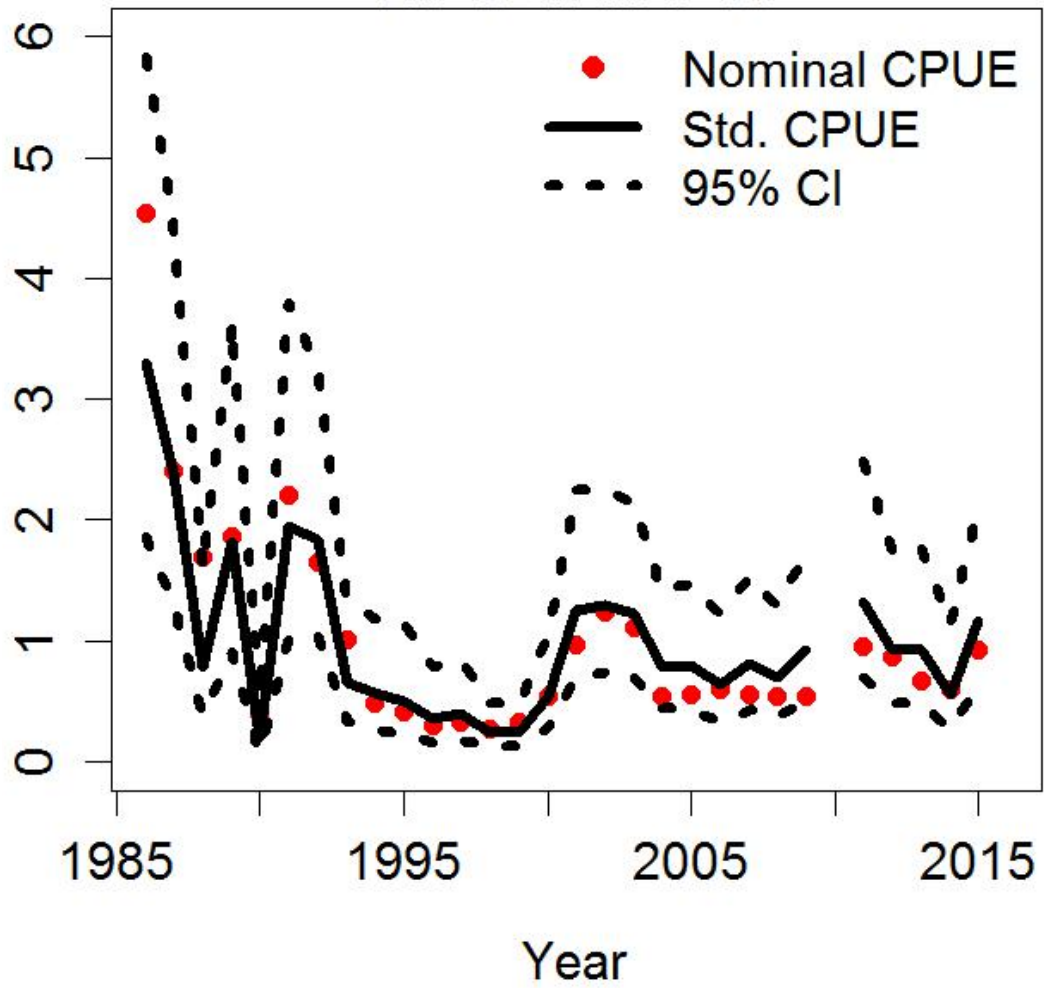


**C.**

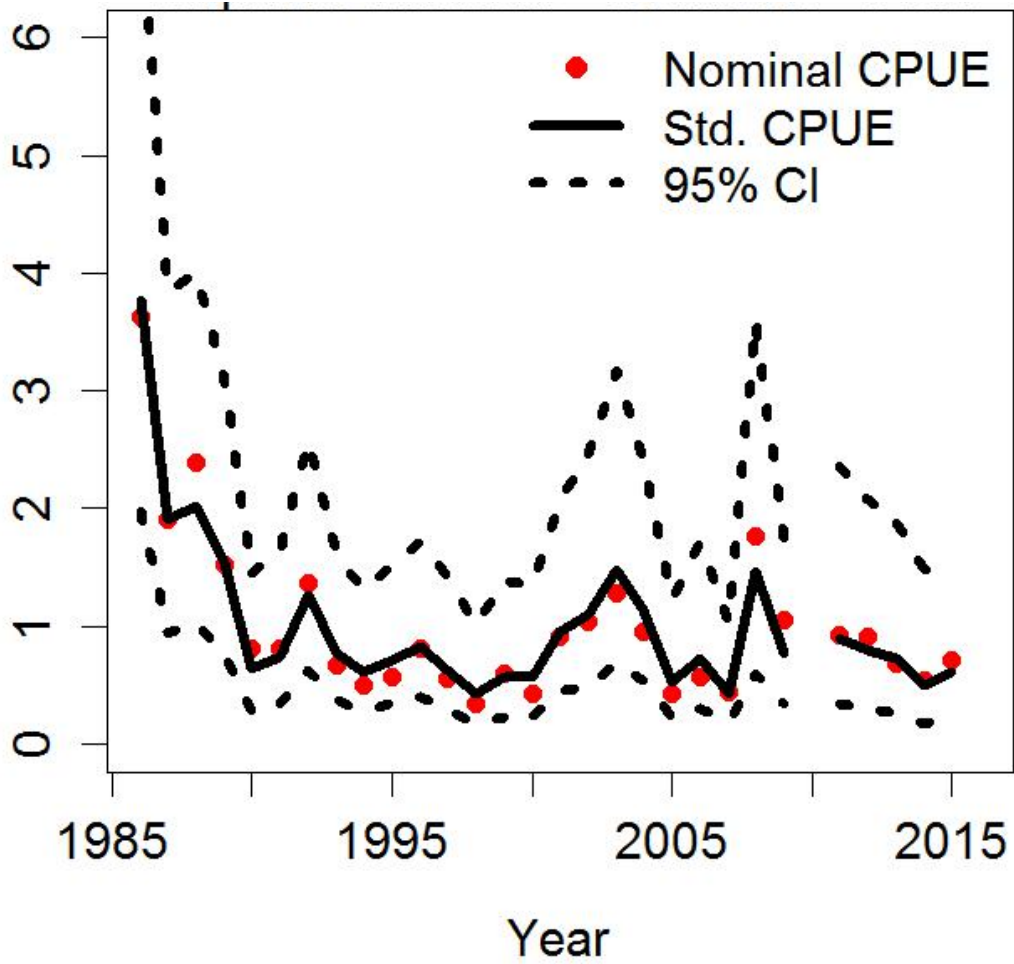
Greater Amberjack HB GULF Data



**Figure 3:** MRFSS nominal CPUE, final standardized CPUE index, and 95% confidence intervals for Gulf of Mexico greater amberjack.

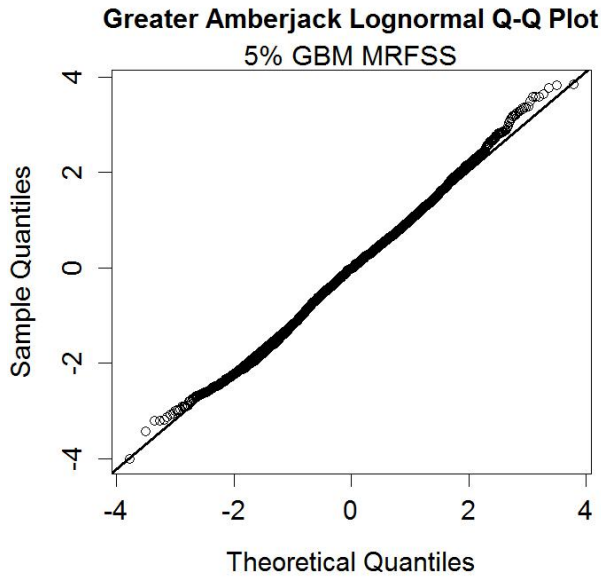


**Figure 4:** Nominal CPUE, final standardized CPUE index, and the 95% confidence intervals for Gulf of Mexico greater amberjack from the headboat fishery.

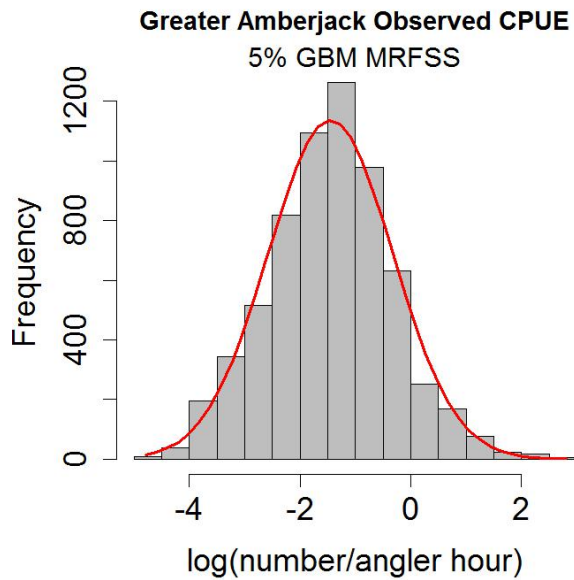


**Figure 5:** Diagnostic plots for the standardized MRFSS index: A) QQ-Plot of CPUE; B) Frequency distribution of catch rates on positive trips (the red line is the expected normal distribution); C) Fit of the binomial proportion positive model to the observed proportion positive values; and D) Plot of the binomial model residuals.

**B.**

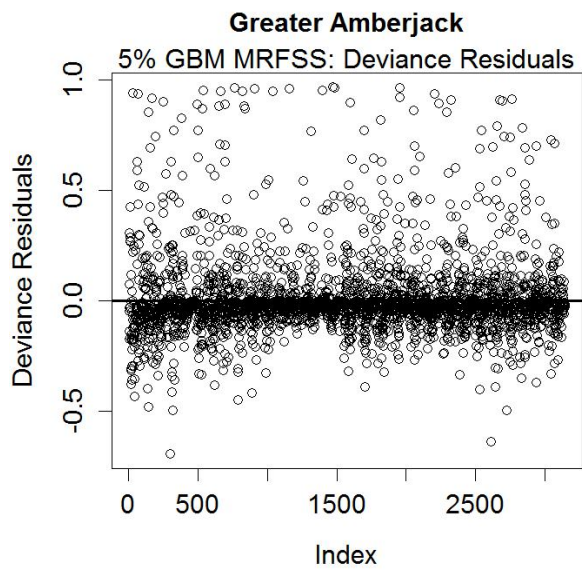
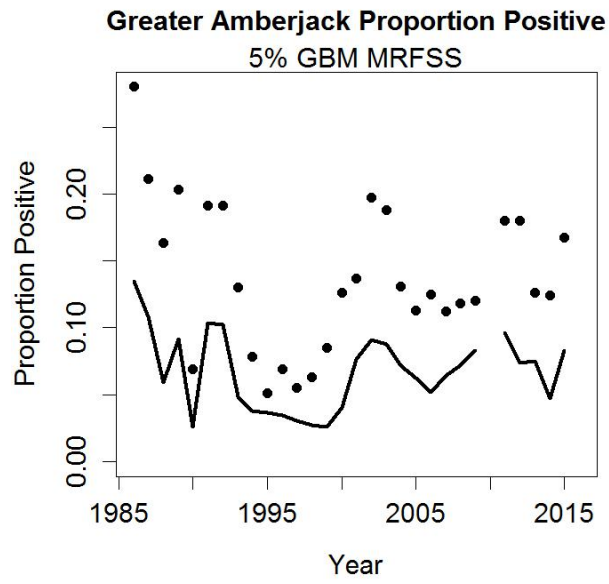


**B.**



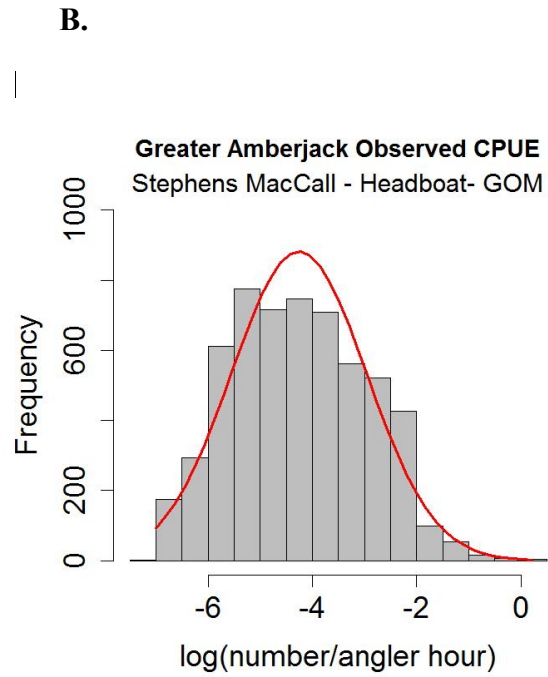
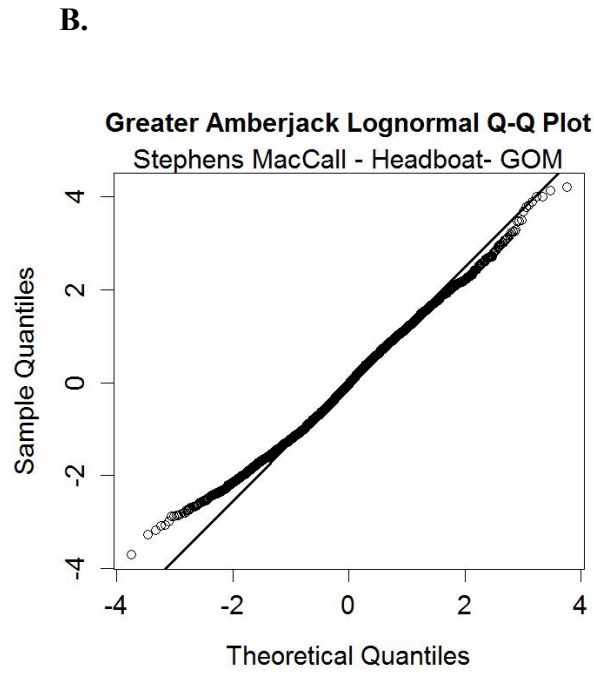
**C.**

**D.**



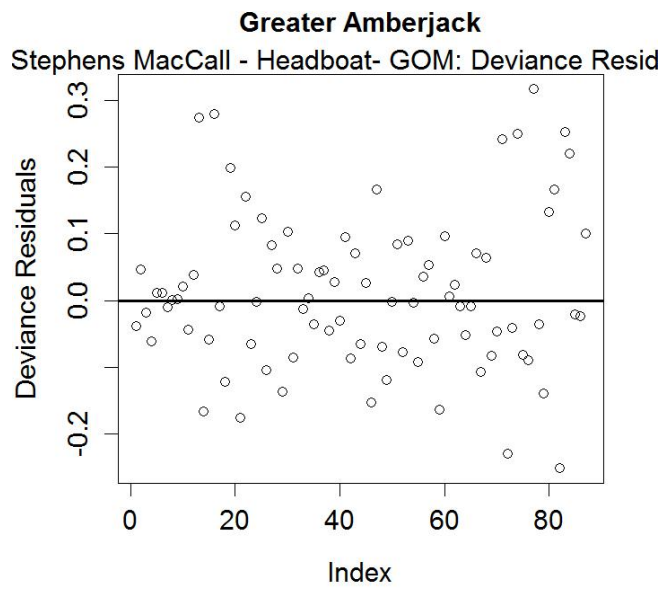
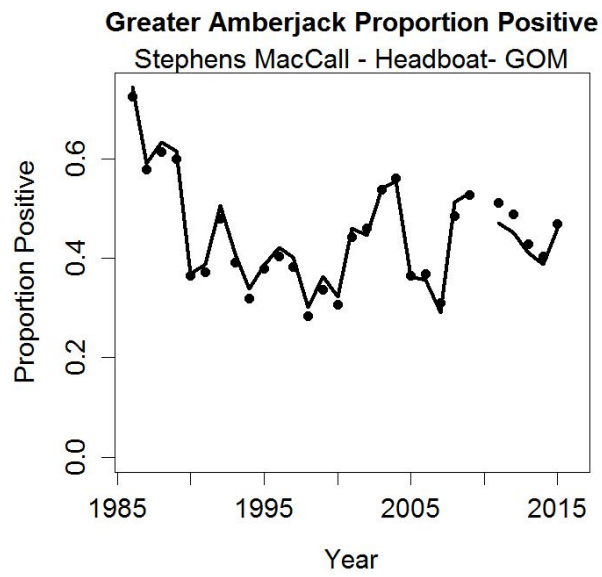


**Figure 6:** Diagnostic plots for the standardized headboat index: A) QQ-Plot of CPUE; B) Frequency distribution of catch rates on positive trips (the red line is the expected normal distribution); C) Fit of the binomial proportion positive model to the observed proportion positive values; and D) Plot of the binomial model residuals.

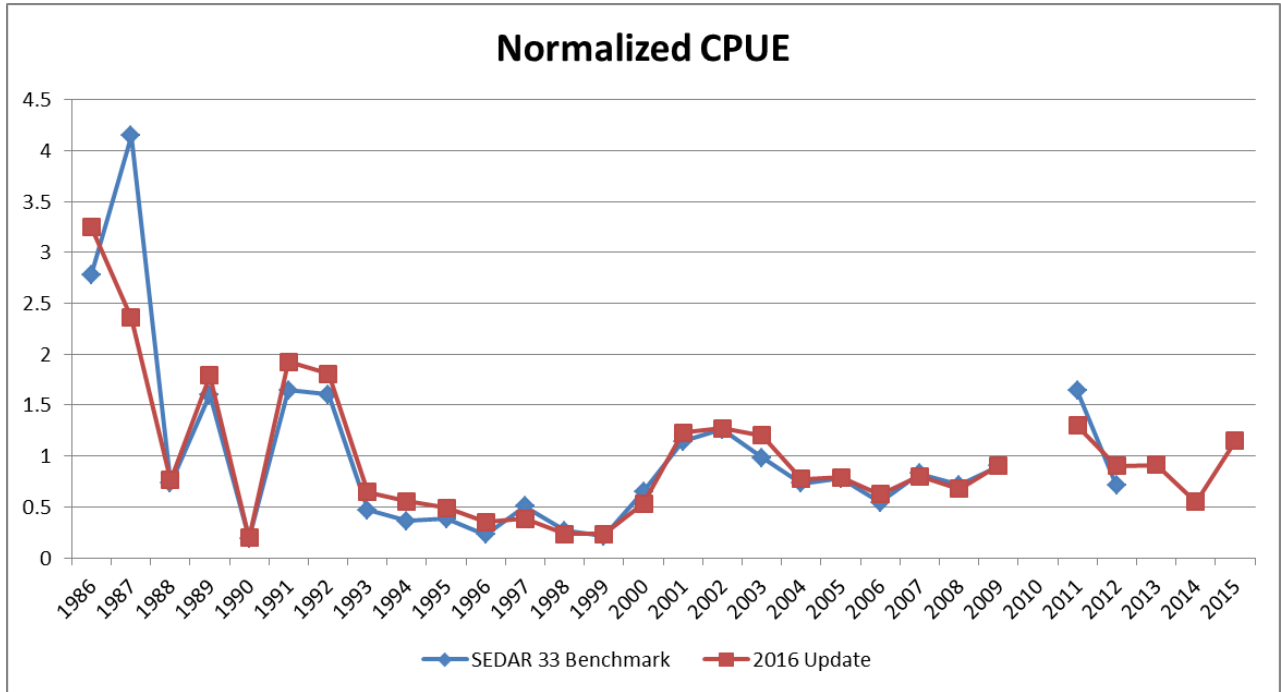


**C.**

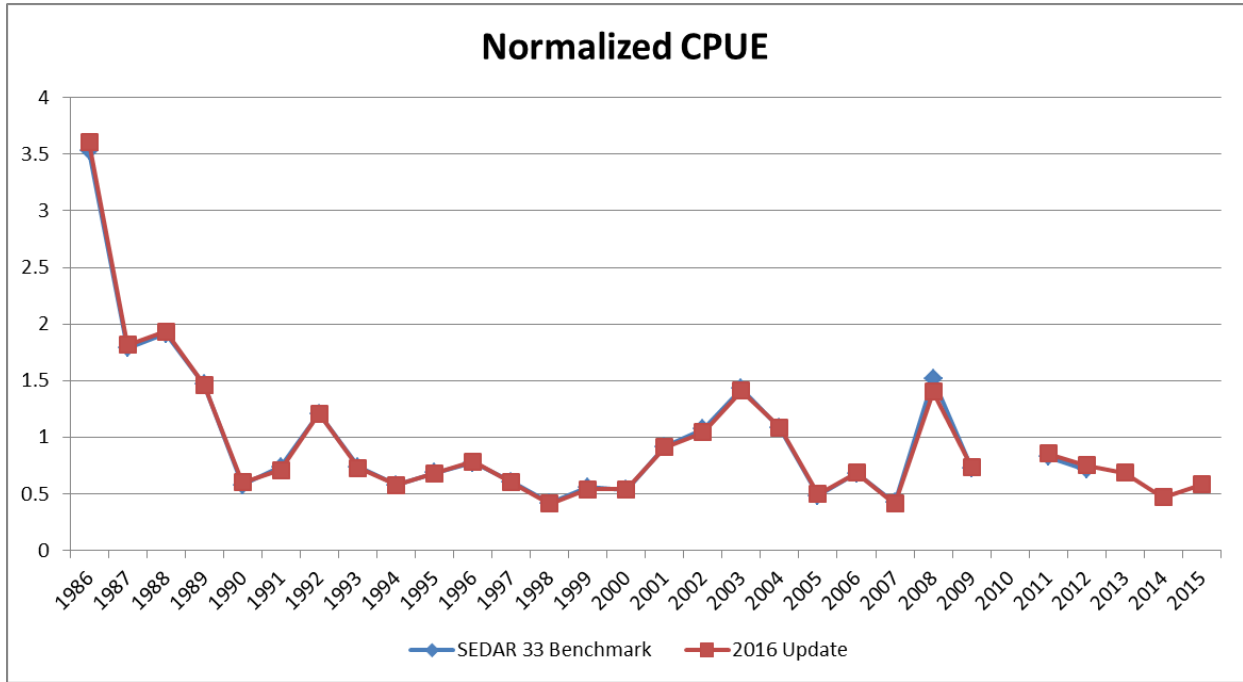
**D.**



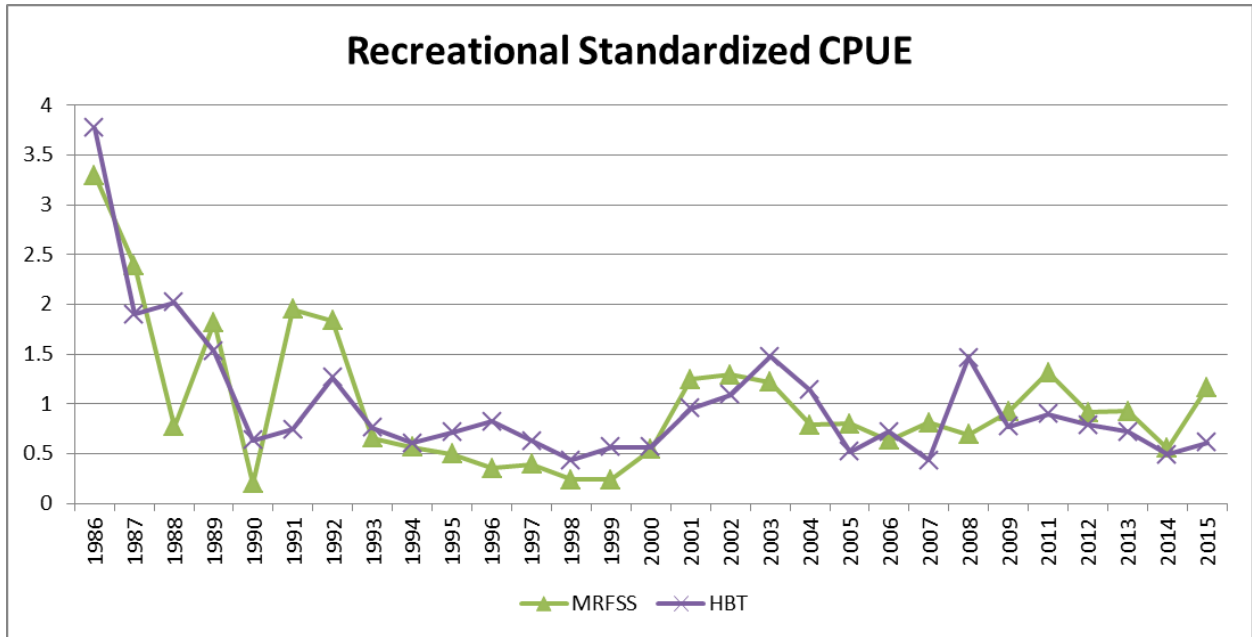
**Figure 7:** Standardized MRFSS CPUE index from the 2013 SEDAR 33 Benchmark compared to the standardized MRFSS indices developed for the 2016 Update. Indices were normalized by their respective means from the overlapping time period (1990-2010).



**Figure 8:** Standardized headboat CPUE index from the 2013 SEDAR 33 Benchmark compared to the standardized headboat index developed for the 2016 Update. Indices were normalized by their respective means from the overlapping time period (1990-2010).



**Figure 9:** Standardized recreational CPUE indices.



## APPENDIX D.

### SS3 MODEL PARAMETERS

Table D.1. Estimated and fixed parameter values and standard deviation for the SEDAR33 update and SEDAR 33 benchmark model.

Parameter	SEDAR 33 update		SEDAR 33 benchmark	
	Value	Stdev	Value	Stdev
L_at_Amin_Fem_GP_1	10	0.000	10	7.922E-05
L_at_Amax_Fem_GP_1	143.6	_	143.6	_
VonBert_K_Fem_GP_1	0.2108	0.0024	0.1958	0.0023
CV_young_Fem_GP_1	0.2	_	0.2	_
CV_old_Fem_GP_1	0.2	_	0.2	_
Wtlen_1_Fem	7.05E-05	_	7.05E-05	_
Wtlen_2_Fem	2.633	_	2.633	_
Mat50%_Fem	82.5	_	82.5	_
Mat_slope_Fem	-0.1	_	-0.1	_
Eggs/kg_inter_Fem	1	_	1	_
Eggs/kg_slope_wt_Fem	0	_	0	_
RecrDist_GP_1	0	_	0	_
RecrDist_Area_1	0	_	0	_
RecrDist_Seas_1	0	_	0	_
CohortGrowDev	0	_	0	_
SR_LN(R0)	7.9309	0.0486	7.9470	0.0481
SR_BH_steep	0.85	_	0.85	_
SR_sigmaR	0.6	_	0.6	_
SR_envlink	0	_	0	_
SR_R1_offset	-0.00180794	0.224	-0.0022435	0.223601
SR_autocorr	0	_	0	_
Early_RecrDev_1970	-0.1517	0.5590	-0.1207	0.5657
Early_RecrDev_1971	-0.1816	0.5509	-0.1419	0.5587
Early_RecrDev_1972	-0.2175	0.5412	-0.1675	0.5499
Early_RecrDev_1973	-0.2577	0.5304	-0.1965	0.5395
Early_RecrDev_1974	-0.3017	0.5189	-0.2255	0.5290
Early_RecrDev_1975	-0.3578	0.5054	-0.2647	0.5168
Early_RecrDev_1976	-0.4130	0.4928	-0.3033	0.5059
Early_RecrDev_1977	-0.4714	0.4799	-0.3515	0.4939
Early_RecrDev_1978	-0.4888	0.4687	-0.3680	0.4825
Early_RecrDev_1979	-0.3902	0.4669	-0.2772	0.4814
Early_RecrDev_1980	0.3679	0.2998	0.4362	0.3038
Early_RecrDev_1981	0.0815	0.3517	0.2827	0.3387
Early_RecrDev_1982	-0.1271	0.3414	-0.0202	0.3616
Early_RecrDev_1983	-0.5912	0.3585	-0.2253	0.3714

Main_RecrDev_1984	-0.1219	0.2523	0.2905	0.1926
Main_RecrDev_1985	0.5689	0.1678	0.6239	0.1569
Main_RecrDev_1986	0.3386	0.1700	0.2969	0.1796
Main_RecrDev_1987	-0.0347	0.1930	-0.0959	0.2081
Main_RecrDev_1988	0.3607	0.1770	0.5813	0.1507
Main_RecrDev_1989	0.5874	0.1542	0.5485	0.1571
Main_RecrDev_1990	-0.0709	0.2935	-0.2114	0.3044
Main_RecrDev_1991	0.2899	0.1486	0.3475	0.1394
Main_RecrDev_1992	-0.1816	0.1831	-0.5779	0.2337
Main_RecrDev_1993	0.3069	0.1278	0.3838	0.1114
Main_RecrDev_1994	-0.0294	0.1765	-0.3023	0.1889
Main_RecrDev_1995	-0.5903	0.2457	-0.4592	0.2056
Main_RecrDev_1996	0.0386	0.1491	-0.1172	0.1519
Main_RecrDev_1997	0.2304	0.1378	0.0206	0.1295
Main_RecrDev_1998	-0.4271	0.2160	-0.2703	0.1334
Main_RecrDev_1999	0.7976	0.1017	0.7097	0.0699
Main_RecrDev_2000	0.7250	0.0968	0.8127	0.0614
Main_RecrDev_2001	0.0323	0.1328	-0.1328	0.0972
Main_RecrDev_2002	-0.5102	0.1286	-0.4953	0.0973
Main_RecrDev_2003	-0.0414	0.0779	-0.1515	0.0685
Main_RecrDev_2004	-0.6802	0.0992	-0.5966	0.0795
Main_RecrDev_2005	-0.4202	0.0842	-0.0730	0.0619
Main_RecrDev_2006	0.1787	0.0625	0.2045	0.0589
Main_RecrDev_2007	0.0366	0.0620	0.1940	0.0679
Main_RecrDev_2008	0.1519	0.0594	0.0137	0.0856
Main_RecrDev_2009	-0.1293	0.0661	-0.7898	0.1611
Main_RecrDev_2010	-0.4184	0.0808	-1.2602	0.2754
Main_RecrDev_2011	-0.0395	0.0809	0.1803	0.1418
Main_RecrDev_2012	-0.4013	0.1295	0.3254	0.6004
Main_RecrDev_2013	-0.149099	0.159		
Main_RecrDev_2014	-0.187383	0.2206		
Main_RecrDev_2015	-0.210598	0.5650		
InitF_1Com_HL_1	0	_	0	_
InitF_2Com_LL_2	0	_	0	_
InitF_3REC_3	0.0315562	0.0122	0.0342	0.0133
InitF_4Headboat_4	0.0111525	0.0038	0.0144	0.0050
Q_envlink_1_Com_HL_1	1.73369	0.3281		
Q_envlink_2_Com_LL_2	-1.7118	0.2232		
LnQ_base_1_Com_HL_1	-7.16177	0.1490		
LnQ_base_2_Com_LL_2	-5.45347	0.1594		
SizeSel_1P_1_Com_HL_1	112.5	_	112.5	_
SizeSel_1P_2_Com_HL_1	-2.60399	0.2467	-4.1966	0.9637
SizeSel_1P_3_Com_HL_1	7.88179	0.1335	7.5650	0.1042

SizeSel_1P_4_Com_HL_1	2.4	_	2.4	_
SizeSel_1P_5_Com_HL_1	-15	_	-15	_
SizeSel_1P_6_Com_HL_1	-1.53418	0.4834	-1.0990	0.4252
Retain_1P_1_Com_HL_1	50.8	_	50.8	_
Retain_1P_2_Com_HL_1	1	_	1	_
Retain_1P_3_Com_HL_1	1	_	1	_
Retain_1P_4_Com_HL_1	0	_	0	_
DiscMort_1P_1_Com_HL_1	-10	_	-10	_
DiscMort_1P_2_Com_HL_1	1	_	1	_
DiscMort_1P_3_Com_HL_1	0.2	_	0.2	_
DiscMort_1P_4_Com_HL_1	0	_	0	_
SizeSel_2P_1_Com_LL_2	106.89	3.0508	105.91	2.85
SizeSel_2P_2_Com_LL_2	36	_	36	_
Retain_2P_1_Com_LL_2	50.8	_	50.8	_
Retain_2P_2_Com_LL_2	1	_	1	_
Retain_2P_3_Com_LL_2	1	_	1	_
Retain_2P_4_Com_LL_2	0	_	0	_
DiscMort_2P_1_Com_LL_2	-10	_	-10	_
DiscMort_2P_2_Com_LL_2	1	_	1	_
DiscMort_2P_3_Com_LL_2	0.2	_	0.2	_
DiscMort_2P_4_Com_LL_2	0	_	0	_
SizeSel_3P_1_REC_3	80.8	_	80.8	_
SizeSel_3P_2_REC_3	-5	_	-5	_
SizeSel_3P_3_REC_3	7.89383	0.2543	7.4318	0.1352
SizeSel_3P_4_REC_3	7.40287	0.2235	7.4936	0.2779
SizeSel_3P_5_REC_3	-15	_	-15	_
SizeSel_3P_6_REC_3	-15	_	-15	_
Retain_3P_1_REC_3	50.8	_	50.8	_
Retain_3P_2_REC_3	1	_	1	_
Retain_3P_3_REC_3	1	_	1	_
Retain_3P_4_REC_3	0	_	0	_
DiscMort_3P_1_REC_3	-10	_	-10	_
DiscMort_3P_2_REC_3	1	_	1	_
DiscMort_3P_3_REC_3	0.2	_	0.2	_
DiscMort_3P_4_REC_3	0	_	0	_
SizeSel_4P_1_Headboat_4	96.8	_	96.8	_
SizeSel_4P_2_Headboat_4	-5	_	-5	_
SizeSel_4P_3_Headboat_4	8.25327	0.2119	7.5570	0.0802
SizeSel_4P_4_Headboat_4	3.00968	0.4756	-8.9384	26.9527
SizeSel_4P_5_Headboat_4	-15	_	-10	_
SizeSel_4P_6_Headboat_4	-1.55919	0.3415	-1.8049	0.3188
Retain_4P_1_Headboat_4	50.8	_	50.8	_
Retain_4P_2_Headboat_4	1	_	1	_



Retain_4P_3_Headboat_4	1	_	1	_
Retain_4P_4_Headboat_4	0	_	0	_
DiscMort_4P_1_Headboat_4	-10	_	-10	_
DiscMort_4P_2_Headboat_4	1	_	1	_
DiscMort_4P_3_Headboat_4	0.2	_	0.2	_
DiscMort_4P_4_Headboat_4	0	_	0	_
SizeSel_6P_1_SEAMAP_Video_Survey_6	43.3398	1.6869	41.1075	1.8831
SizeSel_6P_2_SEAMAP_Video_Survey_6	13.5236	2.3482	14.7907	2.7924
SizeSel_7P_1_PANAMA_CITY_TRAP_VIDEO_SURVEY_7	17.9175	10.3703	17.8	_
SizeSel_7P_2_PANAMA_CITY_TRAP_VIDEO_SURVEY_7	-1.61041	0.5724	-9.9339	71.0739
SizeSel_7P_3_PANAMA_CITY_TRAP_VIDEO_SURVEY_7	5.00994	129.1340	1.7919	0.2364
SizeSel_7P_4_PANAMA_CITY_TRAP_VIDEO_SURVEY_7	2.86602	4.7593	6.8932	0.4367
SizeSel_7P_5_PANAMA_CITY_TRAP_VIDEO_SURVEY_7	-4.1375	1.9658	-999	_
SizeSel_7P_6_PANAMA_CITY_TRAP_VIDEO_SURVEY_7	-1.14347	0.7949	-999	_
AgeSel_1P_1_Com_HL_1	0.1	_	0.1	_
AgeSel_1P_2_Com_HL_1	10	_	10	_
AgeSel_2P_1_Com_LL_2	0.1	_	0.1	_
AgeSel_2P_2_Com_LL_2	10	_	10	_
AgeSel_3P_1_REC_3	0.1	_	0.1	_
AgeSel_3P_2_REC_3	10	_	10	_
AgeSel_4P_1_Headboat_4	0.1	_	0.1	_
AgeSel_4P_2_Headboat_4	10	_	10	_
AgeSel_6P_1_SEAMAP_Video_Survey_6	0.1	_	0.1	_
AgeSel_6P_2_SEAMAP_Video_Survey_6	10	_	10	_
AgeSel_7P_1_PANAMA_CITY_TRAP_VIDEO_SURVEY_7	0.1	_	0.1	_
AgeSel_7P_2_PANAMA_CITY_TRAP_VIDEO_SURVEY_7	10	_	10	_
Retain_1P_1_Com_HL_1_BLK1repl_1950	36.3	_	36.3	_
Retain_1P_1_Com_HL_1_BLK1repl_1990	94.1115	1.2545	95.3011	1.7470
Retain_1P_1_Com_HL_1_BLK1repl_2008	96.2964	1.6502	96.9315	2.1575
Retain_1P_2_Com_HL_1_BLK1repl_1950	6.28338	10.3196	0.6890	2.0062
Retain_1P_2_Com_HL_1_BLK1repl_1990	5.49458	0.4599	7.2467	0.6365
Retain_1P_2_Com_HL_1_BLK1repl_2008	5.92153	0.6102	8.5001	1.2091
Retain_2P_1_Com_LL_2_BLK2repl_1950	17.5	_	17.5	_
Retain_2P_1_Com_LL_2_BLK2repl_1990	105.2330	3.2274	104.0200	2.4552
Retain_2P_2_Com_LL_2_BLK2repl_1950	9.6006	28.2041	11.6285	33.7176
Retain_2P_2_Com_LL_2_BLK2repl_1990	12.7582	1.8543	13.3366	2.0953
Retain_3P_1_REC_3_BLK3repl_1950	0.0417	1.3186	0.0178	0.5660
Retain_3P_1_REC_3_BLK3repl_1991	65.1114	1.7628	63.1805	1.4522
Retain_3P_1_REC_3_BLK3repl_1998	70.8852	1.1040	70.3937	0.9984
Retain_3P_1_REC_3_BLK3repl_2009	78.3356	0.8597	80.6397	1.0566
Retain_3P_2_REC_3_BLK3repl_1950	28.9090	5.7328	27.8359	2.4972
Retain_3P_2_REC_3_BLK3repl_1991	6.7409	1.0512	6.9066	1.1352
Retain_3P_2_REC_3_BLK3repl_1998	4.2829	0.6128	4.4763	0.5827

Retain_3P_2_REC_3_BLK3repl_2009	3.6	_	3.6	_
Retain_4P_1_Headboat_4_BLK3repl_1950	5.2212	5.7429	0.0278	0.8814
Retain_4P_1_Headboat_4_BLK3repl_1991	67.2474	1.4364	64.0529	1.2698
Retain_4P_1_Headboat_4_BLK3repl_1998	70.6796	1.1408	65.9900	1.0619
Retain_4P_1_Headboat_4_BLK3repl_2009	80.1223	2.0557	76.1049	1.4729
Retain_4P_2_Headboat_4_BLK3repl_1950	19.9676	1.0228	11.8381	0.6008
Retain_4P_2_Headboat_4_BLK3repl_1991	6.0434	0.8410	7.7584	1.2338
Retain_4P_2_Headboat_4_BLK3repl_1998	4.9326	0.5845	5.7554	0.7355
Retain_4P_2_Headboat_4_BLK3repl_2009	7.6430	0.8464	6.2823	0.8731

## APPENDIX E.

### SS3 Model diagnostics

a) SEDAR 33 update

b) SEDAR 33 benchmark

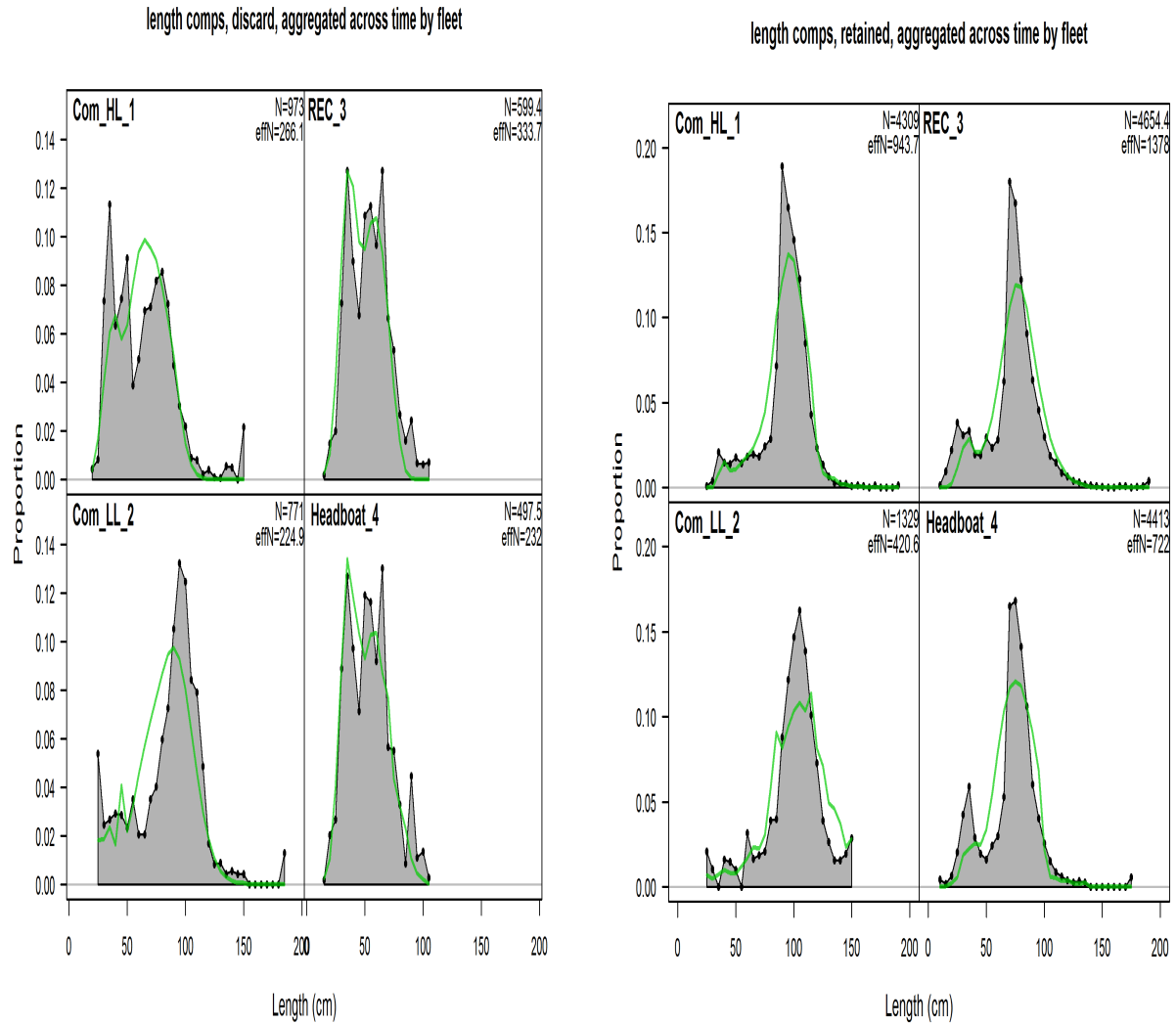
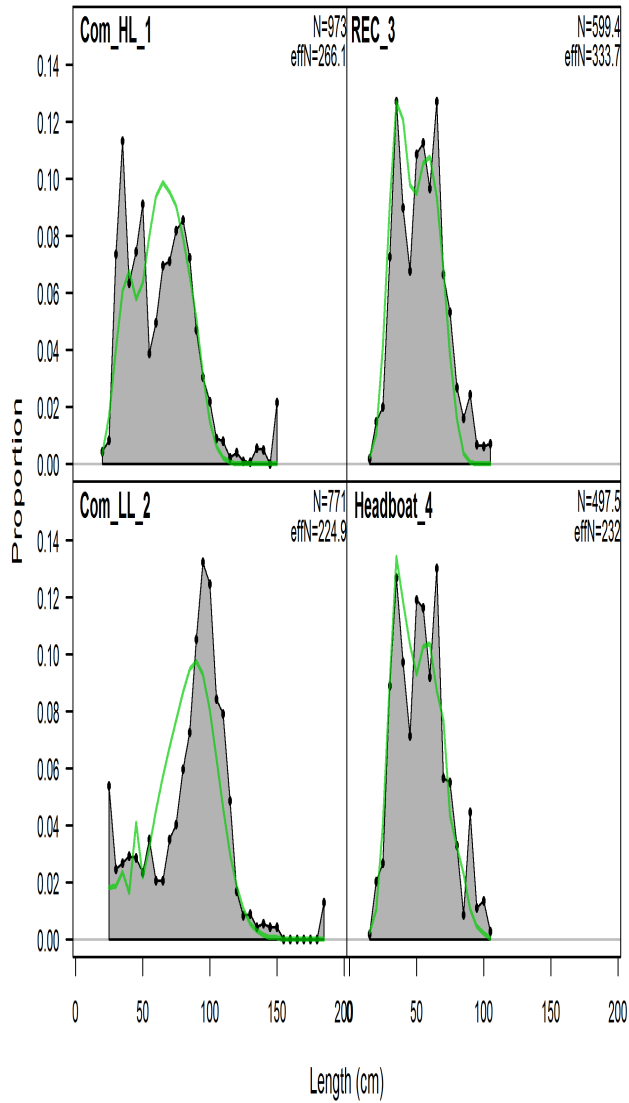


Figure E1. Model fits to the length composition data of retained catch for a) SEDAR 33 Update and b) SEDAR 33

length comps, discard, aggregated across time by fleet



length comps, discard, aggregated across time by fleet

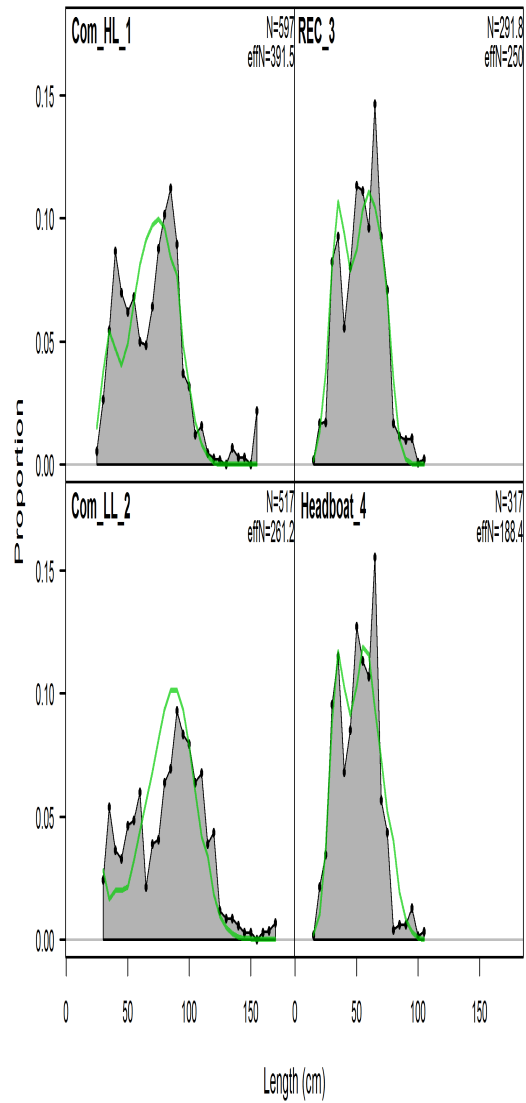


Figure E1. Model fits to the length composition data of discards a) SEDAR 33 update and b) SEDAR 33 benchmark assessment.

length comps, whole catch, aggregated across time by fleet

length comps, whole catch, aggregated across time by fleet

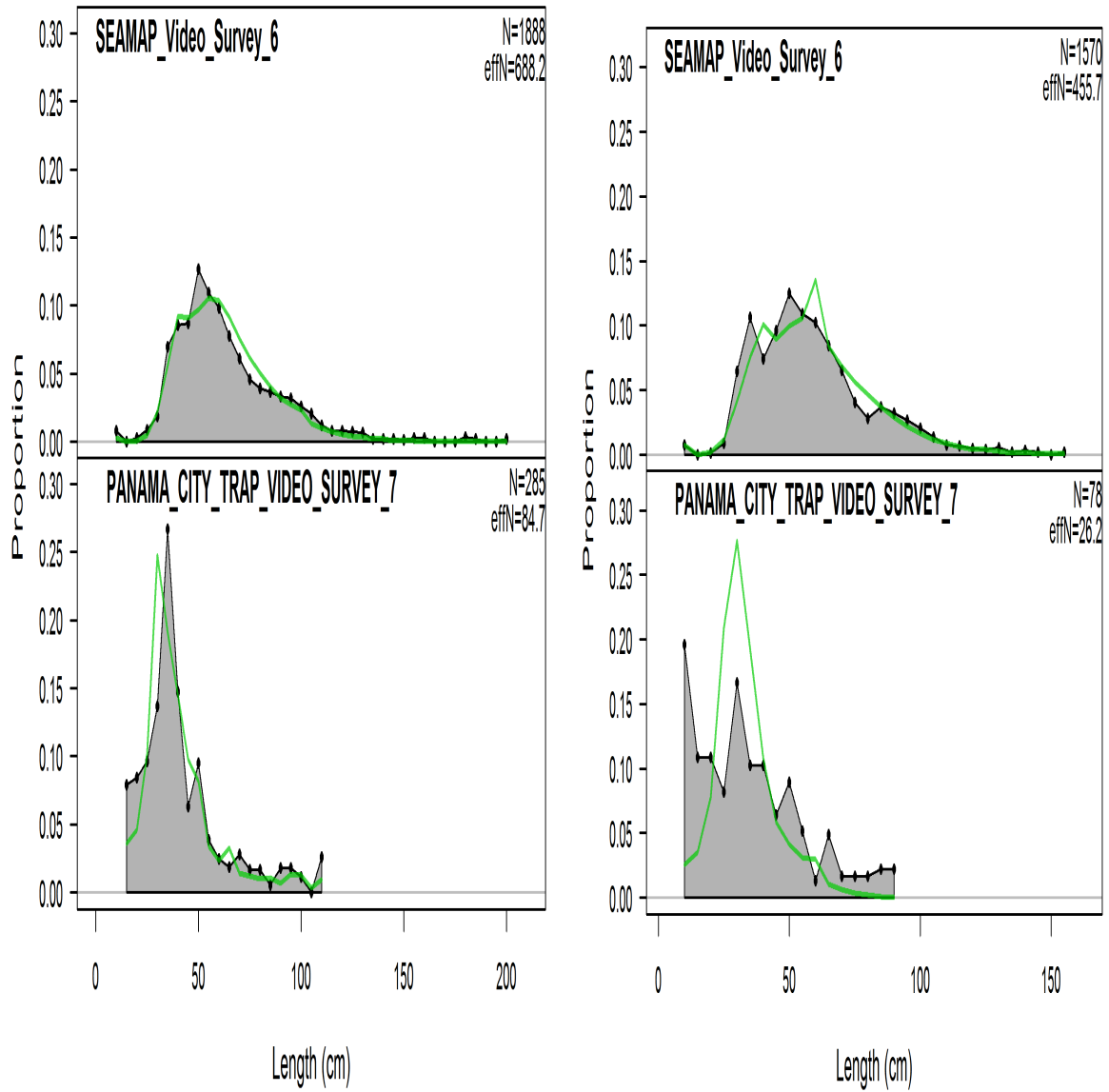
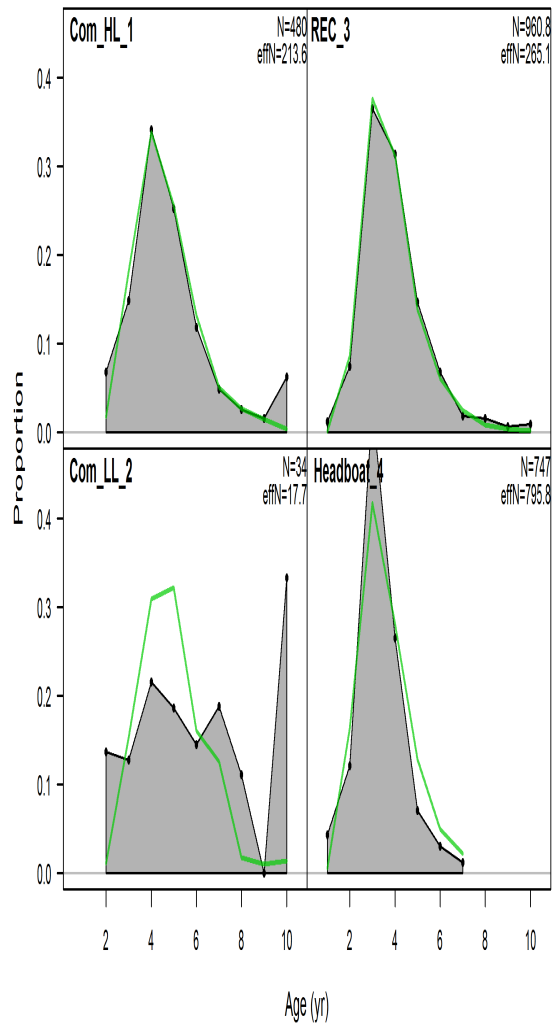


Figure E2. Model fits to the length composition data from fishery-independent indices for a) SEDAR 33 update and b) SEDAR 33 benchmark assessment.

age comps, retained, aggregated across time by fleet



age comps, retained, aggregated across time by fleet

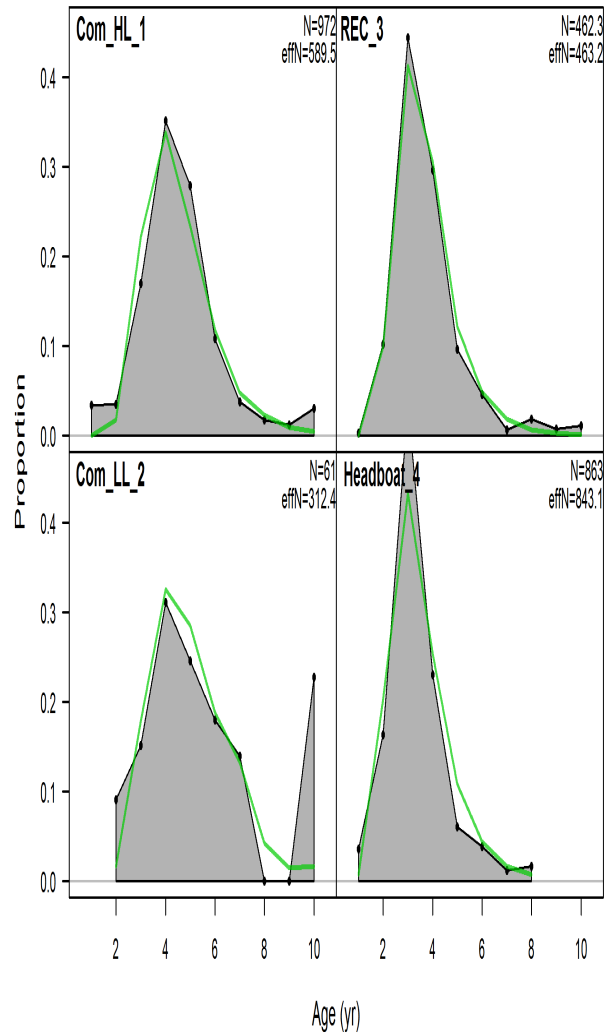
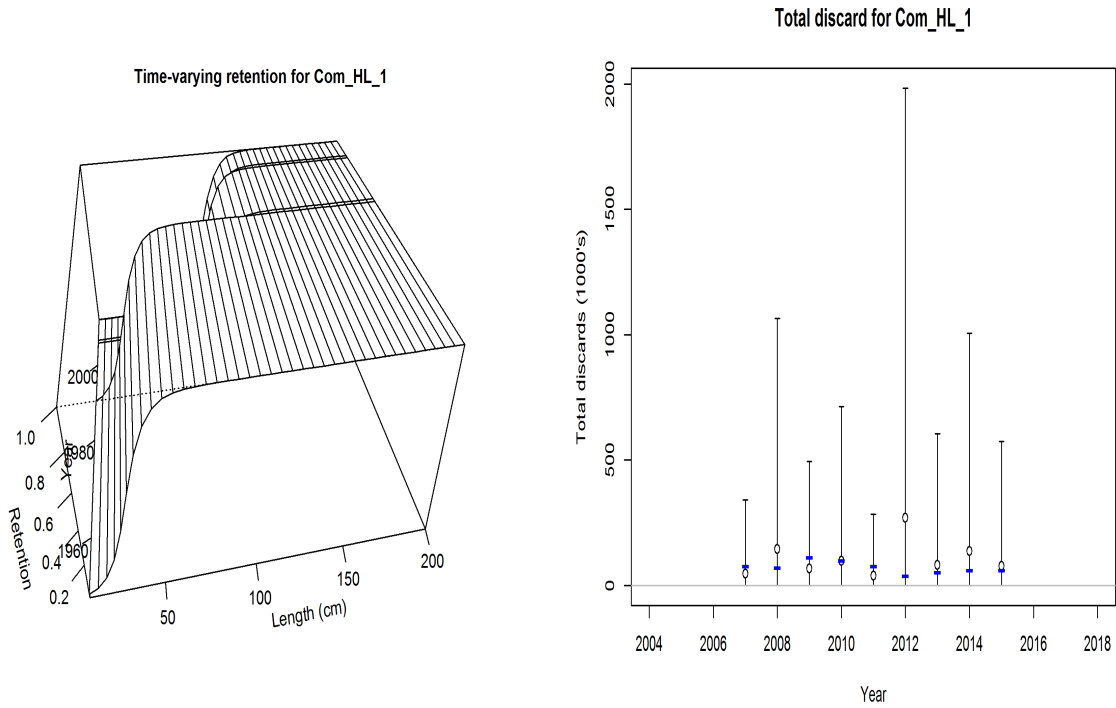


Figure E3. Model fits to the age composition data for a) SEDAR 33 update and b) SEDAR 33 benchmark assessment.

a) SEDAR 33 update



b) SEDAR 33 benchmark

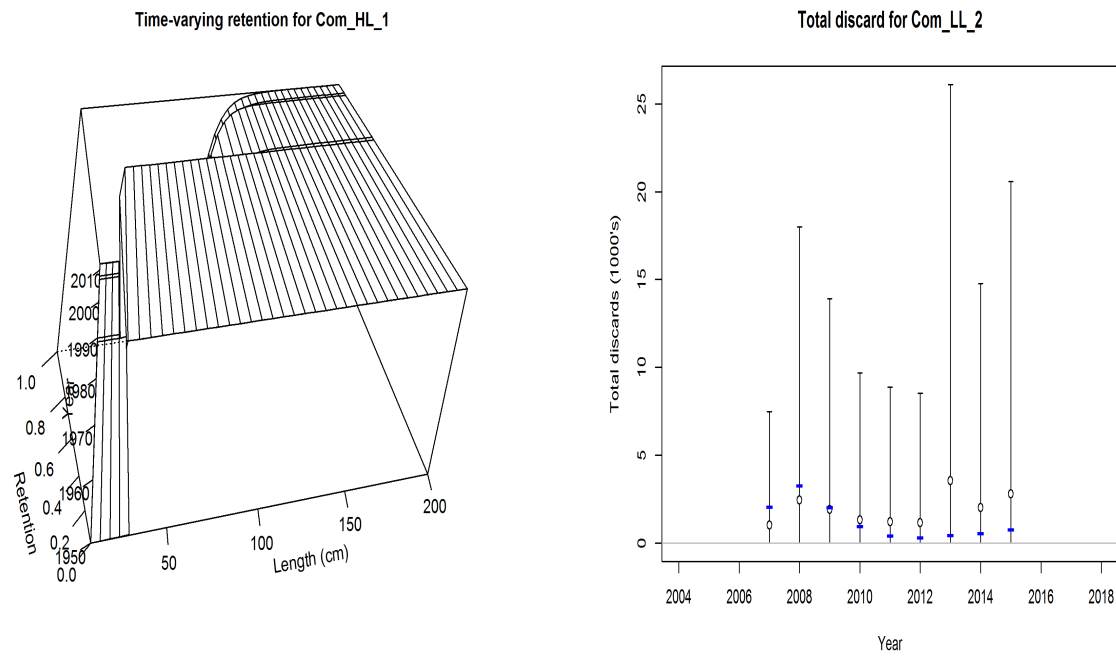
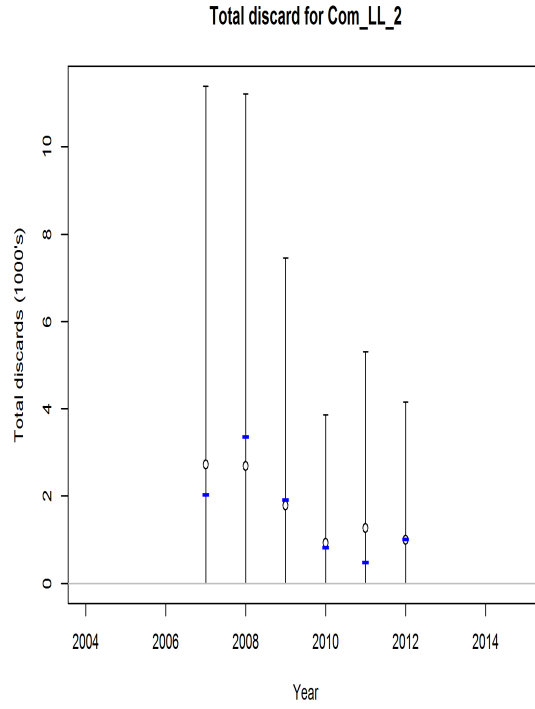
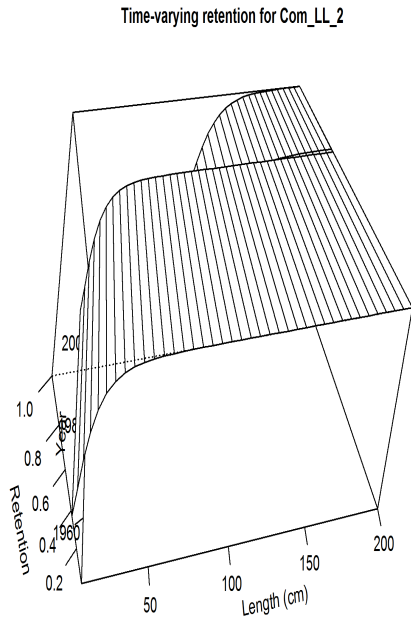


Figure E5. Estimated retention and model fit to the commercial vertical line discards for a) SEDAR 33 update and b) SEDAR 33 benchmark.

a) SEDAR 33 update



SEDAR 33 benchmark

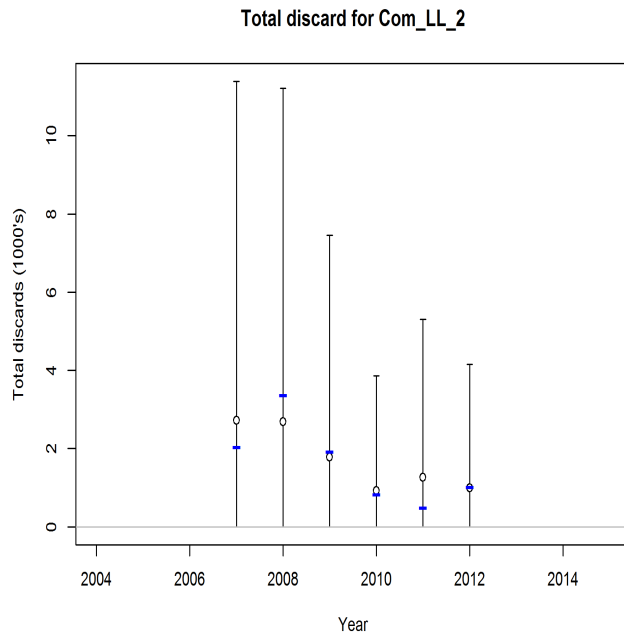
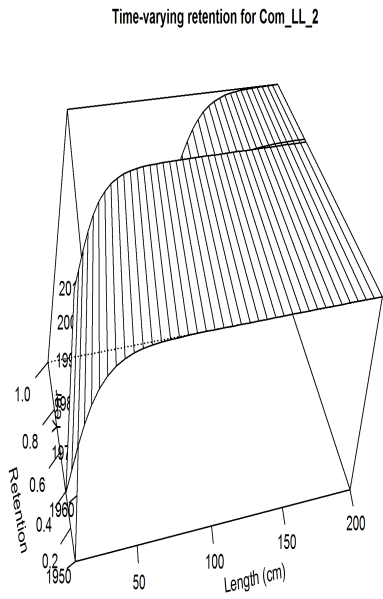
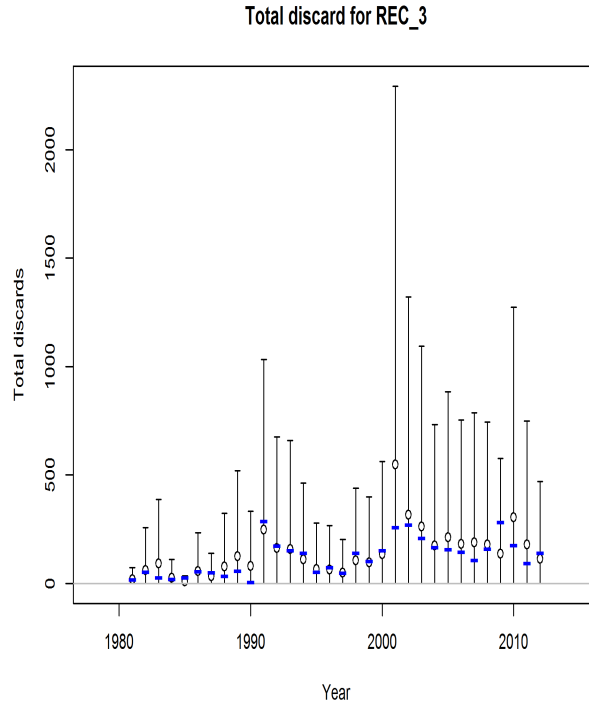
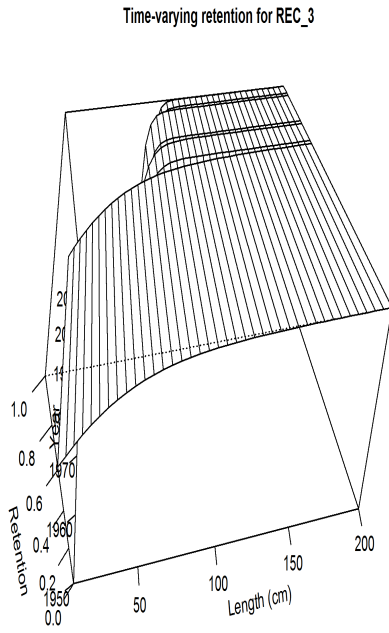


Figure E6. Estimated retention and model fit to the commercial longline discards for a) SEDAR 33 update and b) SEDAR 33 benchmark.



a) SEDAR 33 update



b) SEDAR 33 benchmark

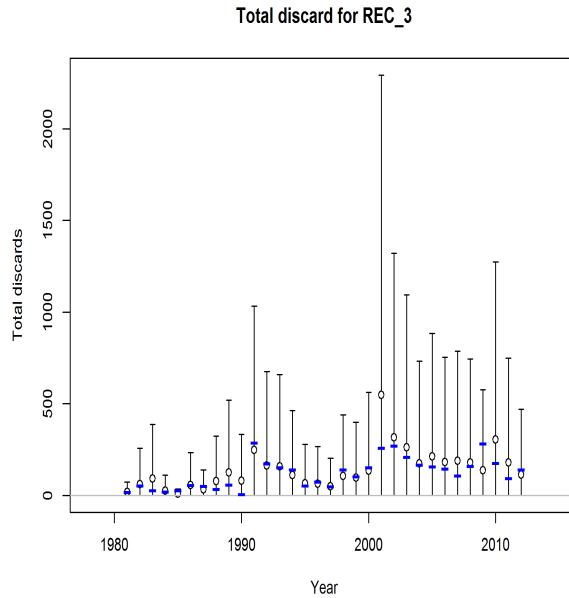
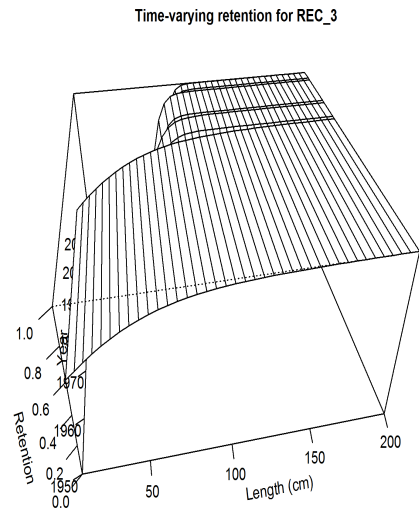
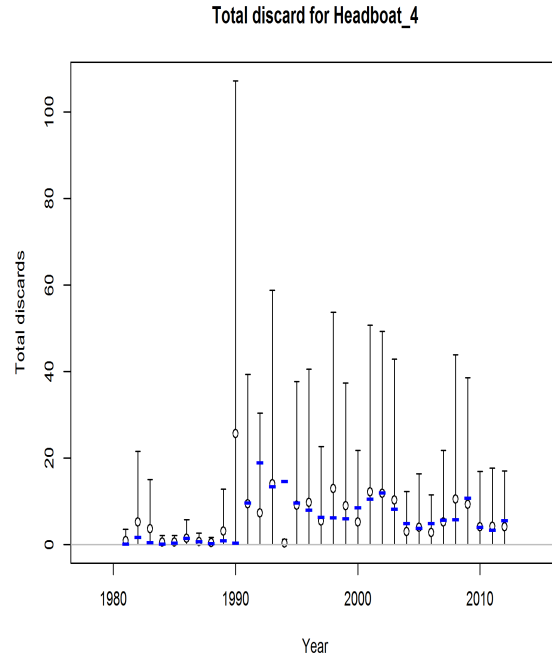
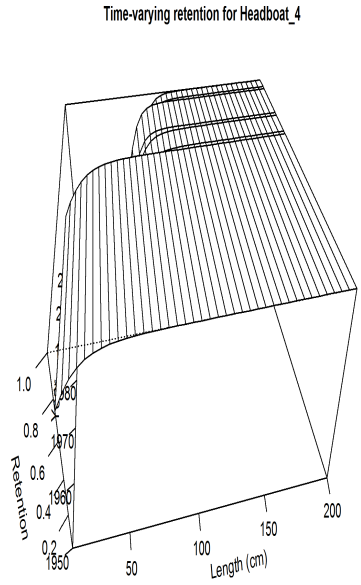


Figure E7. Estimated retention and model fit to the charter and private discards for a) SEDAR 33 and b) SEDAR 33.

a) SEDAR 33 update



b) SEDAR 33 benchmark

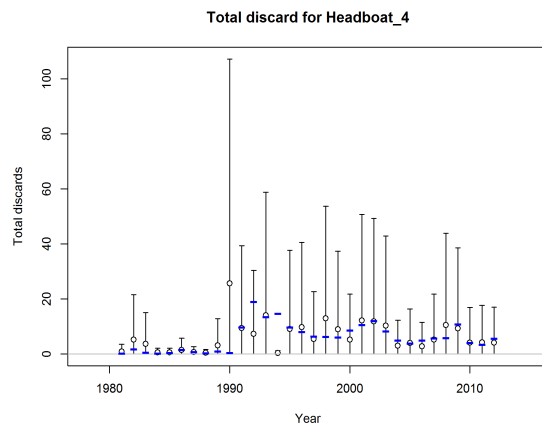
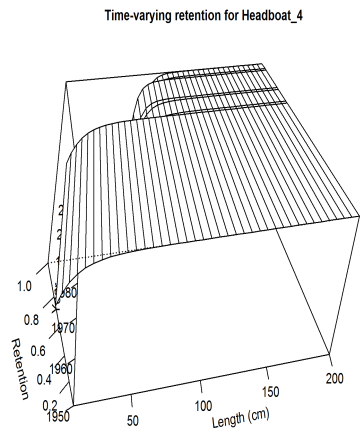
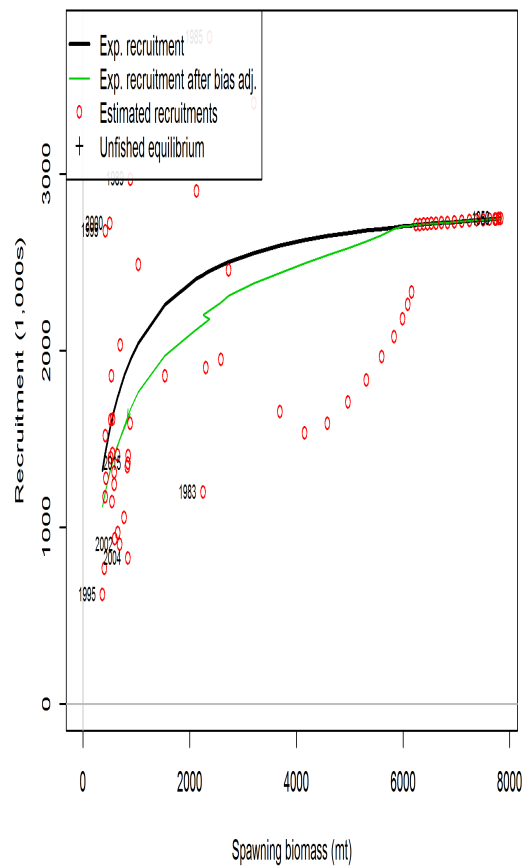


Figure E.4 Estimated retention and model fit to the headboat discards for a) SEDAR 33 and b) SEDAR 33.



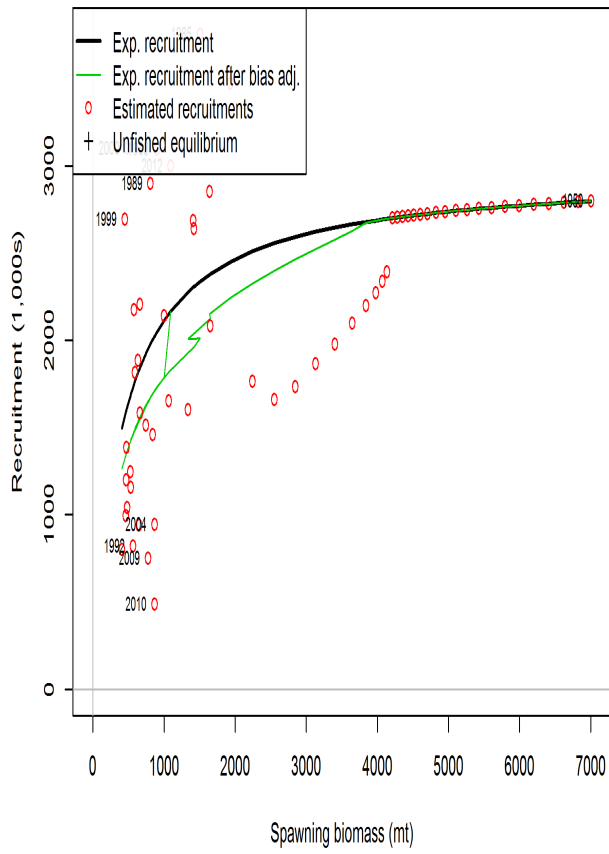


Figure E.12. Estimated stock-recruit relationship for a) SEDAR 33 and b) SEDAR 33.